

Databook



Glydea® and Irismo™

Glydea® ULTRA 60 | Glydea® ULTRA 35 | Irismo™ 45 WireFree RTS | Irismo™ 35 Mini DC

Why Somfy?



Somfy is the leading global manufacturer of strong, quiet, motors with electronic and app controls for interior window coverings and exterior solar protections. Over 270 million users worldwide enjoy the more than 160 million motors produced since 1980. For 50 years, Somfy engineers have designed products for both the commercial and residential markets to motorize window coverings such as interior shades, wood blinds, draperies, awnings, rolling shutters, exterior solar screens and projection screens. Somfy motorization systems are easily integrated with security, HVAC and lighting systems, providing total home or building automation.

Somfy has a committed customer support team comprised of Somfy motor and control specialists available for assistance:

Somfy Corporate Headquarters

800-22-SOMFY (76639)

General Customer Service

877-210-5327

CustomerService_us@somfy.com

Standard Purchase Order

Ordering_us@somfy.com

Rush Purchase Order

ExpeditedShippingOrders_us@somfy.com

Accounting Inquiries

AccountsReceivable@somfy.com

Technical Support

877-233-0019

TechnicalSupport_us@somfy.com

Warranty Claim Requests

us_Return@somfy.com

- Somfy has a production capacity of more than 70,000 motors per day.
- Somfy motors have over 600 standards approvals worldwide.
- Somfy has certified over 100 patents since the year 2000.
- Every Somfy motor goes through an extensive quality assurance process including testing in extreme environmental conditions, for electrostatic discharge, mechanical shock, and high life cycle.
- Somfy has a network of 15,000 trained professional installers throughout the world.

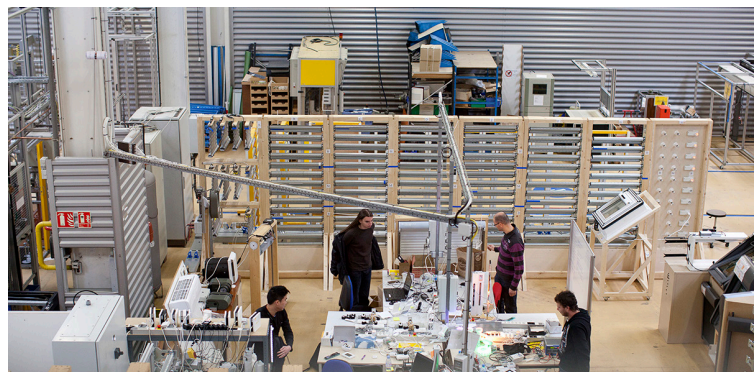

Somfy operates in 60 countries, with 76 subsidiaries, and 60 agencies spread across 5 continents. With 8 production centers, Somfy is an efficient and reactive industry leader. Thanks to its strict quality standards, Somfy is able to satisfy the needs of over 270 million users worldwide.



Somfy understands that training and support are critical to success. Somfy's Expert Program has been developed to provide a platform for those who want to enhance their expertise of motorization and control solutions. Visit www.somfypro.com to learn more.

TABLE OF CONTENTS

| | |
|---|-------|
| INTRODUCTION..... | 2 |
| DRAPERY SYSTEMS AT A GLANCE | 4 |
| MOTOR FEATURES AND MAIN CHARACTERISTICS | 6-11 |
| Motor Summary and Comparison Charts..... | 6-7 |
| <u>WireFree Battery</u> | |
| Irisimo™ 45 WireFree RTS | 8 |
| <u>Low Voltage (24V DC)</u> | |
| Irisimo™ 35 Mini DC | 9 |
| <u>Line Voltage (120V AC)</u> | |
| Glydea® ULTRA 35..... | 10 |
| Glydea® ULTRA 60 | 11 |
| INTEGRATION AND POWER ACCESSORIES | 12-13 |
| WIRING EXAMPLES..... | 14-15 |
| CONTROLS AND ACCESSORIES | 16-17 |
| Radio Technology Somfy® (RTS) | 16-17 |
| Wired Technology | 17 |
| TRACK COMPONENTS AND BRACKETS | 18-19 |
| PRODUCT DIMENSIONAL SPECIFICATIONS | 20-21 |
| Carrier Arm Dimensions | 20 |
| Wall Bracket Dimensions..... | 20 |
| Ceiling Bracket Dimensions | 21 |
| TRACK CONFIGURATIONS | 22-23 |
| TRACK SPECIFICATION CHARTS | 24-25 |
| FABRICATED TRACK OPTIONS | 26 |
| CUSTOM TRACK OPTIONS | 27 |
| BENT DRAPERY TRACK MEASUREMENT FORM | 28 |
| DIRECTIONS FOR CREATING A TEMPLATE FOR DRAPERY CURVES | 29 |
| DRAPERY ORDER FORM..... | 30-31 |
| ENGRAVING BUTTON ORDER FORM | 32 |

Drapery Motor Range

This document presents the technical information and related accessories for Somfy's Glydea® ULTRA and Irismo™ motor ranges designed specifically for draperies. It provides detailed information to facilitate the specification of these motor solutions and presents information regarding options for specialty applications including bent and curved tracks. Information for Somfy's entire product range including motors, power sources, control interfaces etc. can be accessed at www.somfypro.com.

Innovative

The result of years of industry experience and expertise. Reliable motor solutions offer a superior user experience as well as a wide array of features and exemplifies Somfy's continued commitment to quality.

Adaptable

Designed for residential, commercial and hospitality markets, these ranges provide a convenient solution for glare reduction and privacy while also reducing energy costs and protecting interiors from damaging UV rays.

Flexible

Glydea® ULTRA and Irismo™ are available for all drapery types including Pinch Pleat, Ripplefold® and Accordia®. Additionally, they have been designed to easily adapt to various control technologies including infrared, dry contact, Radio Technology Somfy® (RTS), RS485, Z-Wave® and Zigbee®.

Pinch Pleat

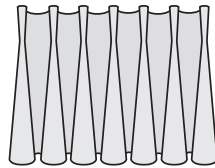

Ripplefold®

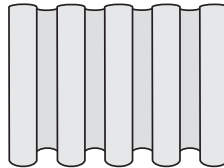

Accordia®

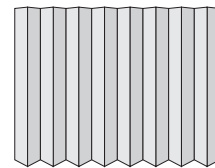

Compatible with various technologies:



Aesthetic

- Clean, premium motor design with built-in control modules.
- Easy to conceal behind drapery fabric
- Adjustable limit setting provides precise alignment of drapery fabric.
- Advanced track design and swivel ceiling brackets minimize light gaps.
- Soft start and soft stop drapery motion
- Improved hardware design provides greater overlap and even stack back.

Easy Installation

- Spring loaded one-touch hardware (wall and ceiling mount)
- Motor can be installed to the right or left side of the drapery track.
- Automatic or adjustable limit setting
- Inverse (top mount) option allows the motor to be installed above the track.

Flexible

- Patented versatile master carrier reduces friction and is adaptable to various drapery types.
- Multiple built-in control options allow seamless integration with third-party systems.
- Adjustable drapery speed control

Ultra Quiet

- Motor design and advanced high-performance belt drive system provide quiet operation (<38dBA).



Somfy
DESIGNED FOR
SILENCE

Efficient

- Touch motion feature allows the user to activate the motorized drapery simply by pulling on the fabric.
- Manual override permits the drapery to be adjusted manually. This is ideal for power outages and also protects the fabric from damage.
- The “my” function allows user to set a preferred drapery opening which provides enhanced convenience.

Somfy quality

5 years international warranty.
International certifications.

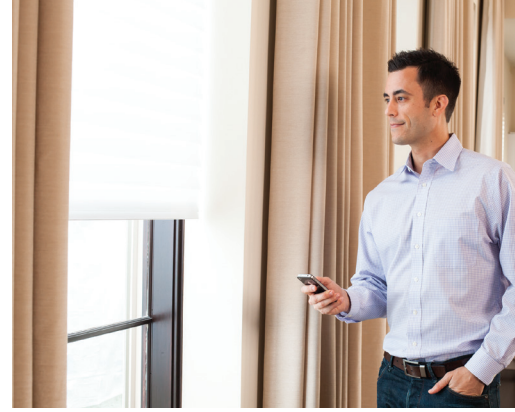

Z-Wave® is a registered trademark of Zensys, Inc. and its subsidiaries.

Zigbee® is a registered trademark of Zigbee® Alliance.

Ripplefold® and Accordia® are registered trademarks of Kirsch.

Amazon, Alexa, and all related logos are trademarks of Amazon.com, Inc. or its affiliates.

All brands, products and trademarks are the property of their respective owners.

Drapery Systems at a Glance

The difference is in the details.

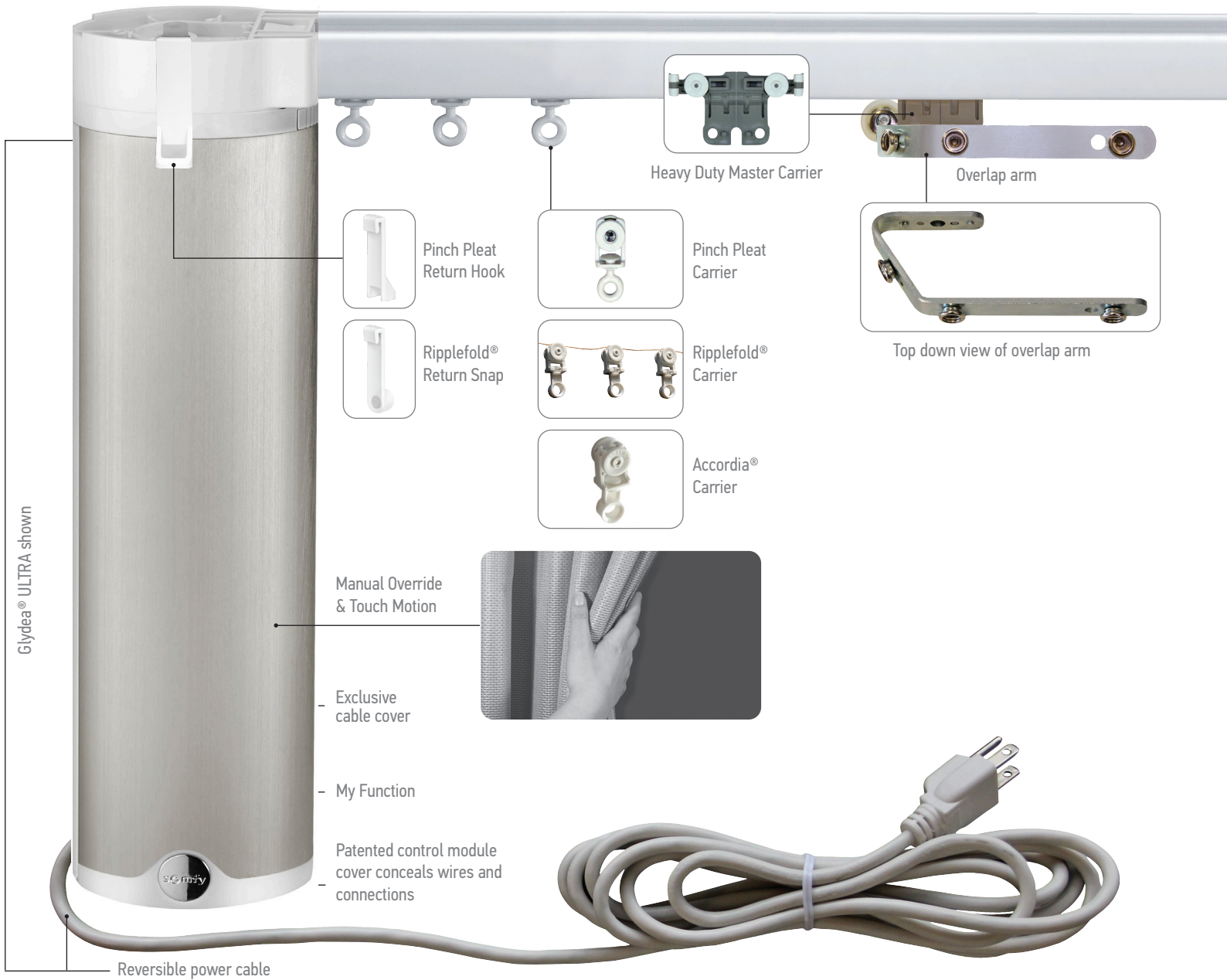

Track bending and curving options available

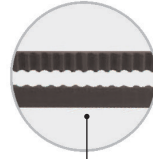

Straight arm

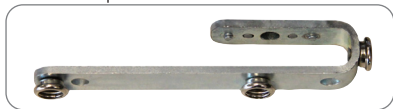

Top down view of straight arm



Easy installation with one-touch ceiling bracket



Swivel ceiling bracket minimizes light gap - recommended for curves



Adjustable wall mount bracket

Belt driven track

Interchangeable left or right side motor mounting option available with center opening track

Any Style, Any Technology

Pinch Pleat

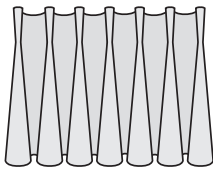

Ripplefold®

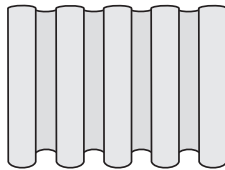

Accordia®

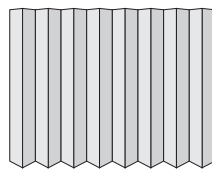

Built-in RTS, DCT and Wired technologies



Optional modules extend control to Zigbee, Z-wave and RS485



FEATURES OVERVIEW COMPARISON CHART

| | WireFree 25.9V DC (Li-ion Rechargeable) | Low Voltage 24V DC | |
|--|--|-----------------------|-----------------|
| | Irisimo™ 45 WireFree RTS | Irisimo™ 35 RTS | Irisimo™ 35 DCT |
| Motor unit main features | | | |
| Soft start | ✓ | ✓ | ✓ |
| Manual operation | ✓ | ✓ | ✓ |
| Automatic limits on end stop | ✓ | ✓ | ✓ |
| Soft stop | ✓ | ✓ | ✓ |
| Intermediate position | ✓ | ✓ | ✓ |
| Touch motion with 2 sensitivity settings | ✓ | ✓ | ✓ |
| Adjustable limits | ✓ | ✓ | ✓ |
| Speed control & adjustment | ✓ | ✓ | ✓ |
| Control options | | | |
| Dry contact input via RJ12 connector | | ✓ | ✓ |
| Dry contact individual, group and master control | | ✓ | ✓ |
| Radio Technology Somfy® RTS | ✓ | ✓ | |
| SDN RS485 digital technology (one-way communication) | | ✓ | ✓ |
| Z-Wave® (one-way communication) | | ✓ | ✓ |
| Zigbee® (one-way communication) | | ✓ | ✓ |
| Tandem alternative | ✓ | ✓ | ✓ |
| Sun control | ✓ | ✓ | ✓ |
| Timer control | ✓ | ✓ | ✓ |
| Installation and setting features | | | |
| Settings with buttons on motor unit | | ✓ | |
| Setting with normally open dry contact switch | | | ✓ |
| LED indicators | ✓ | ✓ | |
| Motor unit direction change | ✓ | ✓ | ✓ |
| Factory reset | ✓ | ✓ | ✓ |
| Inverse (top mount) mounting | ✓ | ✓ | ✓ |
| Audible sound Indicator | ✓ | | |
| Tracks/Drapery Types | | | |
| One-way opening | ✓ | ✓ | ✓ |
| Center opening | ✓ | ✓ | ✓ |
| Asymmetric | ✓ | ✓ | ✓ |
| Multiple | | ✓ | ✓ |
| Pinch pleat | ✓ | ✓ | ✓ |
| Ripplefold® with overlap arm | ✓ | ✓ | ✓ |
| Ripplefold® with butt arm | ✓ | ✓ | ✓ |
| Accordia® | ✓ | ✓ | ✓ |

| | Line Voltage 120V AC | | | |
|--|-------------------------|-----|------------------|-----|
| | Glydea® ULTRA 35 | | Glydea® ULTRA 60 | |
| | DCT | RTS | DCT | RTS |
| Motor unit main features | | | | |
| Soft start | ✓ | ✓ | ✓ | ✓ |
| Manual operation | ✓ | ✓ | ✓ | ✓ |
| Automatic limits on end stop | ✓ | ✓ | ✓ | ✓ |
| Soft stop | ✓ | ✓ | ✓ | ✓ |
| Intermediate position | ✓ | ✓ | ✓ | ✓ |
| Touch motion with 2 sensitivity settings | ✓ | ✓ | ✓ | ✓ |
| Adjustable limits | ✓ | ✓ | ✓ | ✓ |
| Speed control & adjustment | ✓ | ✓ | ✓ | ✓ |
| Control options | | | | |
| Dry contact input via RJ12 connector | ✓ | ✓ | ✓ | ✓ |
| Dry contact individual, group and master control | ✓ | ✓ | ✓ | ✓ |
| Radio Technology Somfy® RTS | | ✓ | | ✓ |
| SDN RS485 digital technology (two-way communication) | ✓ | ✓ | ✓ | ✓ |
| Z-Wave® (one-way communication) | | | | |
| Zigbee® (two-way communication) | ✓ | | ✓ | |
| Tandem alternative | ✓ | ✓ | ✓ | ✓ |
| Sun control | ✓ | ✓ | ✓ | ✓ |
| Timer control | ✓ | ✓ | ✓ | ✓ |
| Installation and setting features | | | | |
| Settings with buttons on motor unit | ✓ | ✓ | ✓ | ✓ |
| Setting with normally open dry contact switch | ✓ | | ✓ | |
| LED indicators | ✓ | ✓ | ✓ | ✓ |
| Motor unit direction change | ✓ | ✓ | ✓ | ✓ |
| Factory reset | ✓ | ✓ | ✓ | ✓ |
| Inverse (top mount) mounting | ✓ | ✓ | ✓ | ✓ |
| Audible sound Indicator | | | | |
| Tracks/Draperies Types | | | | |
| One-way opening | ✓ | ✓ | ✓ | ✓ |
| Center opening | ✓ | ✓ | ✓ | ✓ |
| Asymmetric | ✓ | ✓ | ✓ | ✓ |
| Multiple | ✓ | ✓ | ✓ | ✓ |
| Pinch pleat | ✓ | ✓ | ✓ | ✓ |
| Ripplefold® with overlap arm | ✓ | ✓ | ✓ | ✓ |
| Ripplefold® with butt arm | ✓ | ✓ | ✓ | ✓ |
| Accordia® | ✓ | ✓ | ✓ | ✓ |

Iriso™ 45 WireFree RTS

Technical Specifications

Motor part numbers

Iriso™ 45 WireFree RTS

Part# 1002353

Features overview

| | Iriso™ 45 WireFree RTS |
|--|------------------------|
| Motor unit main features | |
| Soft start | ✓ |
| Soft stop | ✓ |
| Manual operation | ✓ |
| Automatic limits on end stop | ✓ |
| Intermediate position | ✓ |
| Touch motion with 2 sensitivity settings | ✓ |
| Adjustable limits | ✓ |
| Speed control & adjustment | ✓ |
| Control options | |
| Radio Technology Somfy® RTS | ✓ |
| Tandem alternative | ✓ |
| Sun control | ✓ |
| Timer control | ✓ |
| Installation and setting features | |
| LED indicators | ✓ |
| Audible sound Indicator | ✓ |
| Motor unit direction change | ✓ |
| Factory reset/programming button | ✓ |
| Inverse mounting (top mount) | ✓ |
| Tracks/Drapery Types | |
| One-way opening | ✓ |
| Center opening | ✓ |
| Asymmetric | ✓ |
| Pinch pleat | ✓ |
| Ripplefold® with overlap arm | ✓ |
| Ripplefold® with butt arm | ✓ |
| Accordia® | ✓ |

Motorized track main characteristics

| | Iriso™ 45 WireFree RTS |
|---|---|
| Power supply | 25.9V DC |
| Average linear speed | 4.9 in./s - 7.86 in./s 12.5 cm/s - 20 cm/s |
| Rechargeable (Li-ion) battery capacity | 3200 mAh |
| Motor sound level | <44 dBA |
| Certifications | CE |
| Track maximum length | 33 ft. (10 m) |
| Maximum number of splices | 2 |
| Minimum bending radius | 11.8 in. (30 cm) |
| Minimum curving radius | 118 in. (300 cm) |
| Side opening max weight | 99 lbs. (45 kg) |
| Center opening max weight | 99 lbs. (45 kg) |
| Tandem alternative (see pages 23, 24, 26) | 198 lbs. (90 kg) |

Motor dimensions

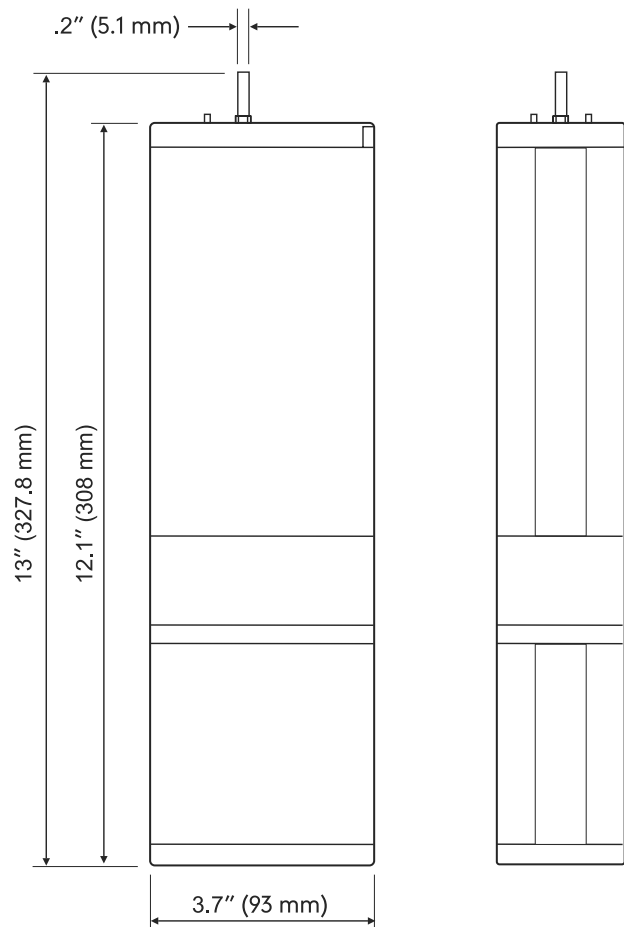

Irismo™ 35 Mini DC

Technical Specifications

Motor part numbers

| | |
|-------------------------------|----------------------|
| Irismo™ 35 Mini DC RTS | Part# 1003004 |
| Irismo™ 35 Mini DC DCT | Part# 1003003 |

Features overview

| | Irismo™ 35 RTS | Irismo™ 35 DCT |
|--|----------------|----------------|
| Motor unit main features | | |
| Soft start | ✓ | ✓ |
| Soft stop | ✓ | ✓ |
| Manual operation | ✓ | ✓ |
| Automatic limits on end stop | ✓ | ✓ |
| Intermediate position | ✓ | ✓ |
| Touch motion with 2 sensitivity settings | ✓ | ✓ |
| Adjustable limits | ✓ | ✓ |
| Speed control & adjustment | ✓ | ✓ |
| Control options | | |
| Dry contact input via RJ12 connector | ✓ | ✓ |
| Radio Technology Somfy® RTS | ✓ | |
| Tandem alternative | ✓ | ✓ |
| SDN RS485 digital technology (one-way communication) | ✓ | ✓ |
| Z-Wave® (one-way communication) | ✓ | ✓ |
| Zigbee® (one-way communication) | ✓ | ✓ |
| Sun control | ✓ | ✓ |
| Timer control | ✓ | ✓ |
| Installation and setting features | | |
| Setting with normally open dry contact switch | ✓ | ✓ |
| LED indicators | ✓ | ✓ |
| Motor unit direction change | ✓ | ✓ |
| Factory reset | ✓ | ✓ |
| Inverse mounting (top mount) | ✓ | ✓ |
| Tracks/Drapery Types | | |
| One-way opening | ✓ | ✓ |
| Center opening | ✓ | ✓ |
| Asymmetric | ✓ | ✓ |
| Multiple | ✓ | ✓ |
| Pinch pleat | ✓ | ✓ |
| Ripplefold® with overlap arm | ✓ | ✓ |
| Ripplefold® with butt arm | ✓ | ✓ |
| Accordia® | ✓ | ✓ |

Motorized track main characteristics

| | Irismo™ 35 RTS | Irismo™ 35 DCT |
|---|---|----------------|
| Power Supply | 24V DC | |
| Power adaptor amperage | 2 A | |
| Average linear speed | 4.9 in./s - 7.86 in./s 12.5 cm/s - 20 cm/s | |
| Power consumption | < 3 W (standby) | |
| Power adaptor cable length | 13.2 ft. (4 m) | |
| Control connector type | RJ12 | |
| DCT control circuit voltage | 5V DC | |
| Motor sound level | <44 dBA | |
| Certifications | CE | |
| Track maximum length | 32 ft. (9.7 m) | |
| Maximum number of splices | 2 | |
| Minimum bending radius | 11.8 in. (30 cm) | |
| Minimum curving radius | 118 in. (300 cm) | |
| Side opening max weight | 77 lbs. (35 kg) | |
| Center opening max weight | 77 lbs. (35 kg) | |
| Tandem alternative (see pages 23, 24, 26) | 154 lbs. (70 kg) | |

Motor dimensions

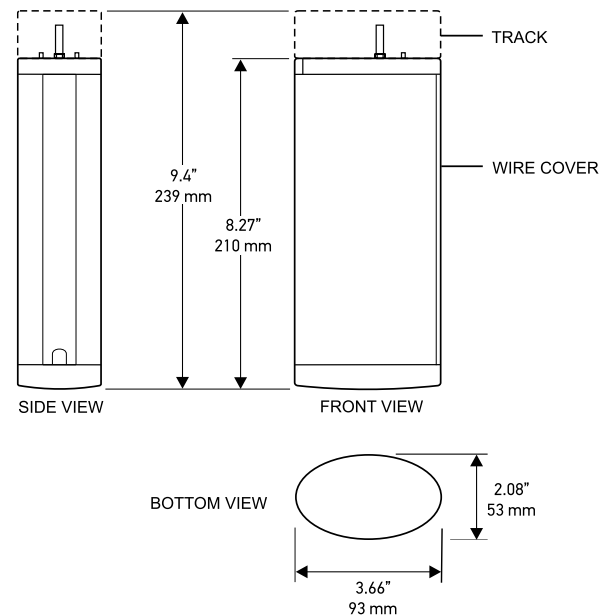

Glydea® ULTRA 35

Technical Specifications

Motor part numbers

| | |
|--|----------------------|
| Glydea® ULTRA 35 RTS motor (with 10' cable and molded NEMA plug) | Part# 1003152 |
| Glydea® ULTRA 35 DCT motor (with 10' cable and molded NEMA plug) | Part# 1003151 |
| Glydea® ULTRA 35 Wired Motor (5' long without plug) | Part# 1003153 |

Features overview

| | Glydea® ULTRA 35 |
|--|---------------------|
| Motor unit main features | |
| Soft start | ✓ |
| Manual operation | ✓ |
| Automatic limits on end stop | ✓ |
| Soft stop | ✓ |
| Intermediate position | ✓ |
| Touch motion with 2 sensitivity settings | ✓ |
| Adjustable limits | ✓ |
| Speed control & adjustment | ✓ |
| Control options | |
| Dry contact input via RJ12 Connector | ✓ |
| Dry contact individual, group and master control | ✓ |
| Radio Technology Somfy® RTS | ✓ |
| SDN RS485 digital technology (two-way communication) | ✓ |
| Zigbee® (two-way communication) (DCT only) | ✓ |
| Tandem alternative | ✓ |
| Sun control | ✓ |
| Timer control | ✓ |
| Installation and setting features | |
| Settings with buttons on motor unit | ✓ |
| Setting with 3 normally open dry contact switch | ✓ |
| LED indicators | ✓ |
| Motor unit direction change | ✓ |
| Factory reset | ✓ |
| Inverse (top mount) mounting | ✓ |
| Tracks/Drapery Types | |
| One-way opening | ✓ |
| Center opening | ✓ |
| Asymmetric | ✓ |
| Multiple | ✓ |
| Pinch pleat | ✓ |
| Ripplefold® with overlap arm | ✓ |
| Ripplefold® with butt arm | ✓ |
| Accordia® | ✓ |

Motorized track main characteristics

| | Glydea® ULTRA 35 |
|--|---|
| Power Supply | 120V AC 50/60 HZ |
| Amperage | 0.8 A |
| Average linear speed | Silent Mode: 2.95 in./s (7.5 cm/s) Standard Mode: 4.95 in./s -7.86 in./s (12.5 cm/s-20 cm/s) |
| Power consumption | 96W (standby <1W) |
| Power cable type | 3-wire cable with molded NEMA plug 4-wire cable (wired version only) |
| Control connector type (Dry Contact) | RJ12 |
| DCT control circuit voltage | 3.3 VDC |
| Motor sound level | <38 dBA at silent mode |
| Certifications | c TUV us, CE |
| Track maximum length | 32 ft. (9.7 m) |
| Maximum number of splices | 2 |
| Minimum bending radius | 11.8 in. (30 cm) |
| Minimum curving radius | 118 in. (300 cm) |
| Side opening max weight | 77 lbs. 35 kg. |
| Center opening max weight | 77 lbs. 35 kg. |
| Tandem alternative (see pages 23, 24, 26) | 154 lbs./ 70 kgs. 64 ft./ 19.4 m |

Motor dimensions

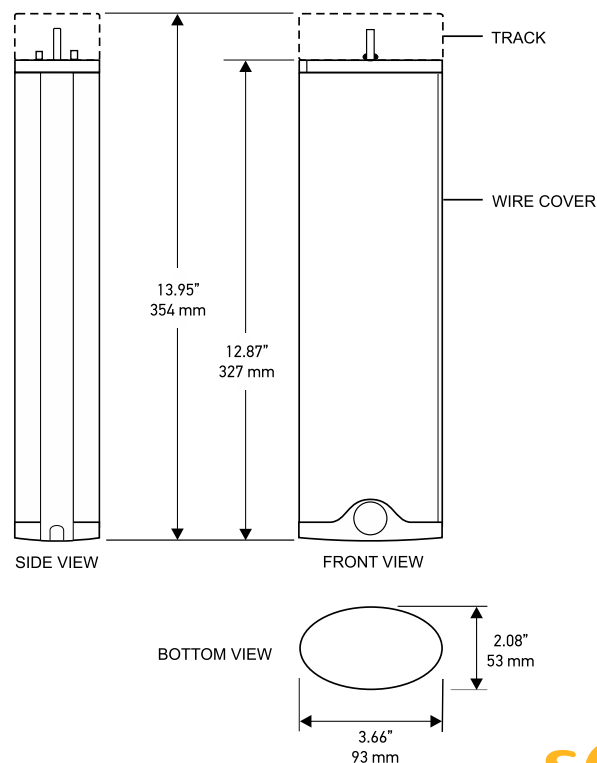

Glydea® ULTRA 60

Technical Specifications

Motor part numbers

| | |
|--|----------------------|
| Glydea® ULTRA 60 RTS motor (with 10' cable and molded NEMA plug) | Part# 1003159 |
| Glydea® ULTRA 60 DCT motor (with 10' cable and molded NEMA plug) | Part# 1003158 |
| Glydea® ULTRA 60 Wired motor (5' long without plug) | Part# 1003160 |

Features overview

| Glydea® ULTRA 60 | |
|--|---|
| Motor unit main features | |
| Soft start | ✓ |
| Manual operation | ✓ |
| Automatic limits on end stop | ✓ |
| Soft stop | ✓ |
| Intermediate position | ✓ |
| Touch motion with 2 sensitivity settings | ✓ |
| Adjustable limits | ✓ |
| Speed control & adjustment | ✓ |
| Control options | |
| Dry contact input via RJ12 Connector | ✓ |
| Dry contact individual, group and master control | ✓ |
| Radio Technology Somfy® RTS | ✓ |
| SDN RS485 digital technology (two-way communication) | ✓ |
| Zigbee® (two-way communication) (DCT only) | ✓ |
| Tandem alternative | ✓ |
| Sun control | ✓ |
| Timer control | ✓ |
| Installation and setting features | |
| Settings with buttons on motor unit | ✓ |
| Setting with 3 normally open dry contact switch | ✓ |
| LED indicators | ✓ |
| Motor unit direction change | ✓ |
| Factory reset | ✓ |
| Inverse (top mount) mounting | ✓ |
| Tracks/Drapery Types | |
| One-way opening | ✓ |
| Center opening | ✓ |
| Asymmetric | ✓ |
| Multiple | ✓ |
| Pinch pleat | ✓ |
| Ripplefold® with overlap arm | ✓ |
| Ripplefold® with butt arm | ✓ |
| Accordia® | ✓ |

Motorized track main characteristics

| Glydea® ULTRA 60 | |
|--|---|
| Power Supply | 120V AC 50/60 HZ |
| Amperage | 0.8 A |
| Average linear speed | Silent Mode: 2.95 in./s (7.5 cm/s) Standard Mode: 4.95 in./s -7.86 in./s (12.5 cm/s-20 cm/s) |
| Power consumption | 96W (standby <1W) |
| Power cable type | 3-wire cable with molded NEMA plug 4-wire cable (wired version only) |
| Control connector type (Dry Contact) | RJ12 |
| DCT control circuit voltage | 3.3 VDC |
| Motor sound level | <38 dBA at silent mode |
| Certifications | c TUV us, CE |
| Track maximum length | 36 ft. (10.9 m) |
| Maximum number of splices | 2 |
| Minimum bending radius | 11.8 in. (30 cm) |
| Minimum curving radius | 118 in. (300 cm) |
| Side opening max weight | 132 lbs. 60 kg. |
| Center opening max weight | 132 lbs. 60 kg. |
| Tandem alternative (see pages 23, 24, 26) | 264 lbs./ 120 kgs. 72 ft./ 21.8 m |

Motor dimensions

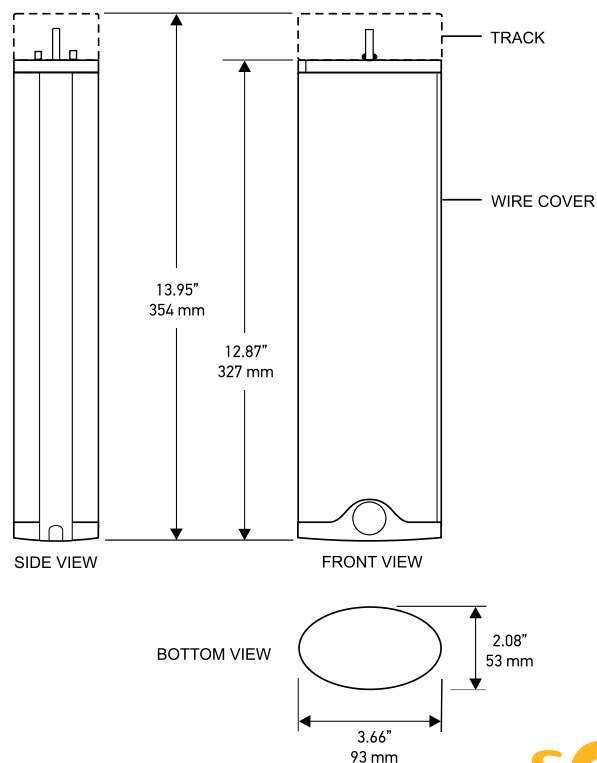

Irismo™ 35 Mini DC Drapery Motor, Integration and Power

IRISMO™ 35

Irismo™ 35 Mini DC



RTS 1003004
DCT 1003003

(24V DC power supply included)
(Optional 10 motor power panel available)

Please see pages 14 & 15 for wiring examples.
See below for power accessories.

CONTROL CARD ENCLOSURE FOR IRISMO™ 35

DC Control Card Enclosure



DC Control Card Enclosure
9021132

ENCLOSURE/CONTROL KITS

Z-Wave® Drapery
Control Enclosure Kit

1870280

Zigbee® Drapery
Control Enclosure Kit

1870281

SDN Irismo™ 35 24V Mini DC
Control Enclosure Kit
(includes cable for SDN & PoE)

1870282

INTEGRATION CONTROL MODULES FOR IRISMO™ 35 ONLY

Z-Wave®

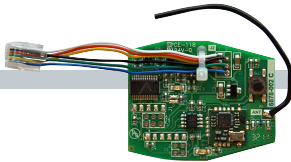

Easily integrates with
Z-Wave® systems using the
Z-Wave® plug-in module.

1870228

Zigbee®

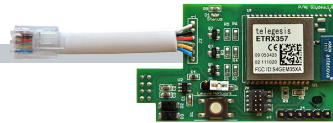

Easily integrates with Zigbee®
systems using the Zigbee®
plug-in module.

1870221

RS485

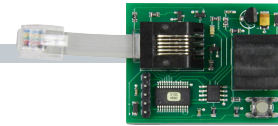

Easily integrates with Somfy
Digital Network™ systems using
the RS485 plug-in module.

1811129

POWER ACCESSORIES FOR IRISMO™ 35

Power Panel



SDN bus distribution component used to add
10 isolated motor ports and two isolated
device ports to an SDN bus segment.

1870259

PoE Gateway



Low voltage power distribution and network-connected
module that utilizes PoE (Power over Ethernet)
technology to power and control the Somfy 24V RS485
motorization offer for shades and draperies.

1860326

Drapery Adaptor for Power Over Ethernet (PoE) Gateway



4-pin Weidmuller Adaptor to connect
the SDN PoE Gateway to motors.

9025012

Irismo™ 45 and Glydea ULTRA® Drapery Motors, Integration and Power

IRISMO™ 45

Irismo™ 45 WireFree RTS



RTS 1002353

(Rechargeable Lithium-ion battery pack included)

Power Charger 1003080 &
Replacement Battery 9026476
(Sold Separately)

GLYDEA® ULTRA

Glydea® ULTRA 35 and Glydea® ULTRA 60



Glydea® ULTRA 35

| | |
|--------------------------|---------|
| RTS with 10' Plug | 1003152 |
| DCT with 10' Plug | 1003151 |
| Wired w/o Plug | 1003153 |

Glydea® ULTRA 60

| | |
|--------------------------|---------|
| RTS with 10' Plug | 1003159 |
| DCT with 10' Plug | 1003158 |
| Wired w/o Plug | 1003160 |

POWER ACCESSORIES FOR IRISMO™ 45

Plug-in Charger for Irismo™ 45



With 5 ft. cable - 20 AWG
1003080 (replaces 1002945)

Rechargeable Battery for Irismo™ 45



9026476 (replaces 9019741)

INTEGRATION CONTROL MODULES FOR GLYDEA® ULTRA RTS & DCT MOTORS

RS485 Two-Way Module

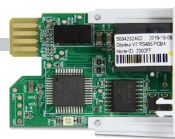

RS485 Two-way Module for
Glydea® ULTRA Motors

1870275

Drapery Motor Wiring Examples



RTS RADIO CONTROL

Individual control

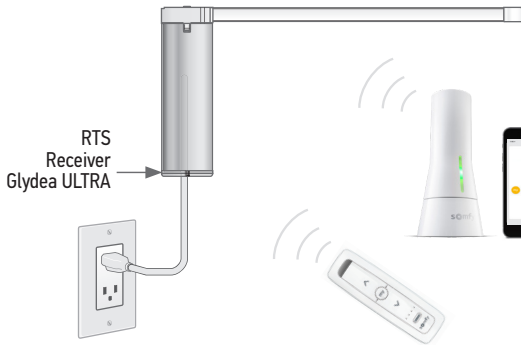

Group control

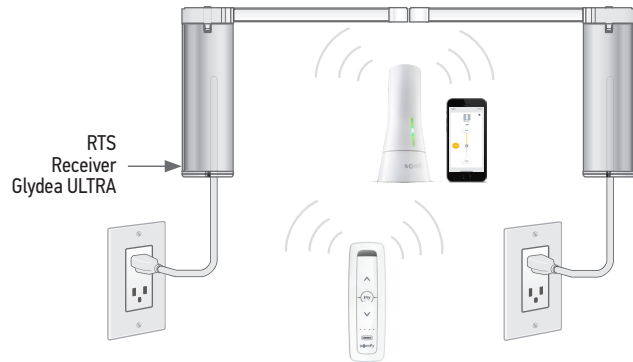

DRY CONTACT TECHNOLOGY (DCT) CONTROL

DRY CONTACT

The Dry Contact Control can be done through devices with 2 normally open contacts (open, close) or 3 normally open contacts (open, stop, close). For devices using 2 contacts, the stop command is achieved by closing the open and close contacts. For 3 devices, the stop can also be achieved with a specific stop button. Individual, group and master DCT controls can be achieved using a DCT Splitter and Diode boxes as shown below.

NUMBER OF DCT DRAPERY MOTORS AND LENGTH OF CONTROL LIMITATIONS

| WIRE CROSS-SECTION | MAXIMUM LENGTH OF CABLE | MAXIMUM NUMBER OF MOTORS |
|----------------------|-------------------------|--------------------------|
| Cat5 or Equal | 328 ft. (100 m) | 10 |
| 0.75 mm ² | 656 ft. (200 m) | 20 |

Individual control

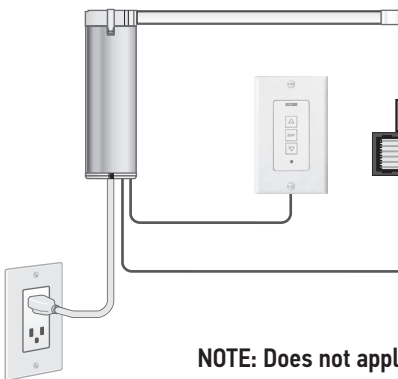

RJ12 SOCKET PIN OUT

For legacy motors

- 6) CW - CLOSE
- 5) STOP
- 4) +5V
- 3) GROUND COMMON
- 2) IR OUT
- 1) CCW - OPEN

For Glydea ULTRA

- 6) CW - CLOSE
- 5) STOP
- 4) NO USE
- 3) GROUND COMMON
- 2) NO USE
- 1) CCW-OPEN

Group control

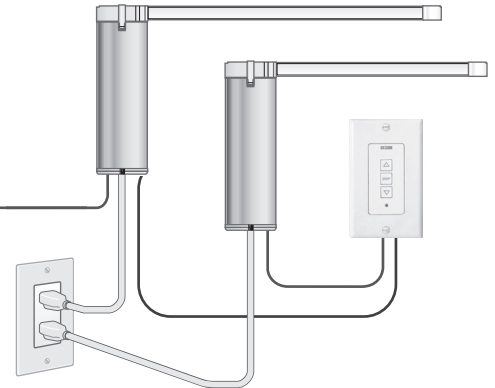

NOTE: Does not apply to Irismo™ 45 WireFree

WIRED CONTROL



Individual control

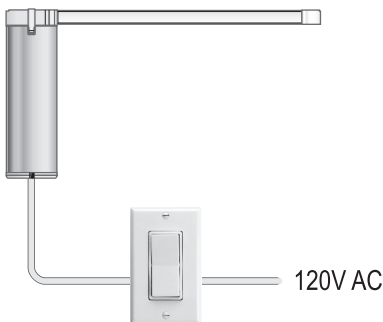

| | |
|--------------|---------|
| Brown | Dir1 |
| Black | Dir2 |
| Blue | Neutral |
| Green/Yellow | Ground |

Group control

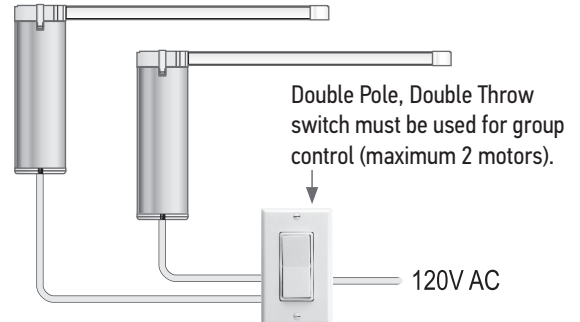

NOTE: Examples are for illustrative purposes. Additional components may be needed depending on your installation.
Applies to Glydea ULTRA range only.

Drapery Motor Wiring Examples



SOMFY DIGITAL NETWORK (SDN) WIRING EXAMPLES

Plug-in:

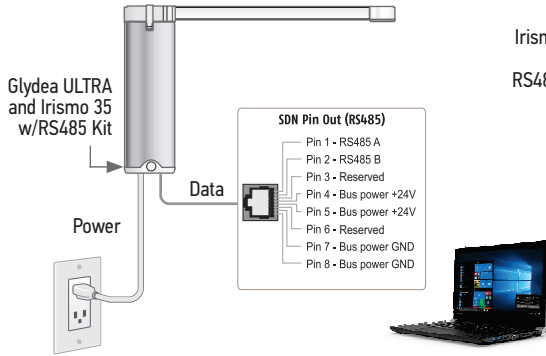

Power Panel:

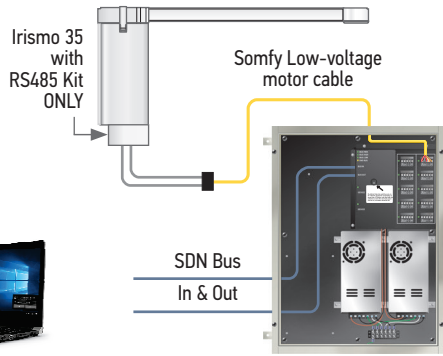

Power over Ethernet (PoE):

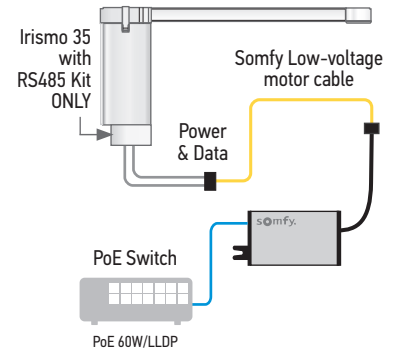

NOTES: Contact Somfy for additional details.

Z-WAVE® CONTROL



Individual control

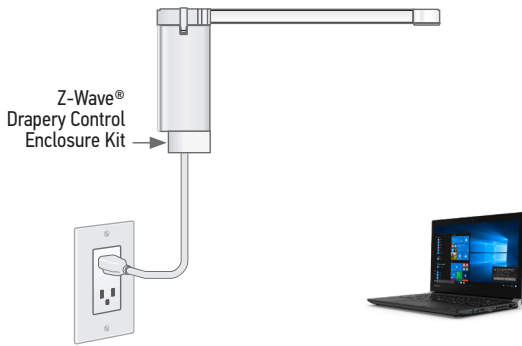

Group and individual control

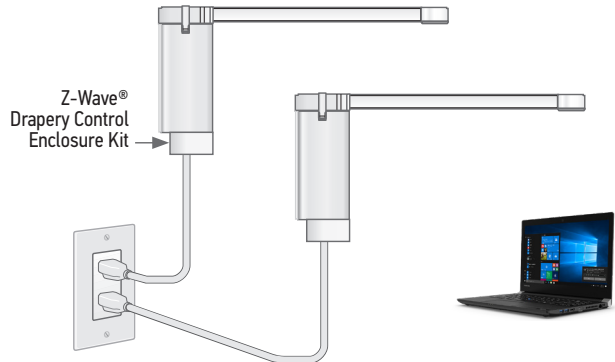

NOTES: Applies to Irismo 35 Mini DC only. Please see page 12 for more details.

ZIGBEE® CONTROL (IRISMO 35 MINI DC)



Group and individual control



NOTES: Examples are for illustrative purposes. Additional components may be needed depending on your installation. Does not apply to Irismo™ 45 WireFree. Not compatible with TaHoma.

Drapery Controls and Accessories

Learn more about controls and accessories at www.somfy.com/controls



RADIO TECHNOLOGY SOMFY® (RTS)

SITUO & TELIS HAND-HELD REMOTE COLLECTIONS



Situot® 1 RTS
Pure Single
Channel Remote
1870571



Situot® 5 RTS
Pure Five
Channel Remote
1870575



Situot® 1 RTS
Iron Single
Channel Remote
1870572



Situot® 5 RTS
Iron Five
Channel Remote
1870576



Situot® 1 RTS
Natural Single
Channel Remote
1870573



Situot® 5 RTS
Natural Five
Channel Remote
1870577



Situot® 1 RTS
Arctic Single
Channel Remote
1870574



Situot® 5 RTS
Arctic Five
Channel Remote
1870578



Situot® 5 RTS
Soliris Five
Channel Remote
1870579



Situot® 5 RTS
Variation Five
Channel Remote
1811612



Telis 16 Channel RTS
Pure Remote with
On-screen display
1811081



Telis 16 Channel RTS
Silver Remote with
On-screen display
1811082



Telis 1 Chronis RTS
Pure Timer with
On-screen display
1805237

DECOFLEX WIREFREE™ WALL SWITCHES



DecoFlex 1 Channel RTS
WireFree™ Wall Switch



DecoFlex 2 Channel RTS
WireFree™ Wall Switch



DecoFlex 3 Channel RTS
WireFree™ Wall Switch



DecoFlex 4 Channel RTS
WireFree™ Wall Switch



DecoFlex 5 Channel RTS
WireFree™ Wall Switch



Smoove® 1 RTS Pure



Smoove® 4 RTS Pure

- Wall Switches shown in white. Also available in black and ivory finishes.
- Shown assembled with printed channel buttons.
- Custom engraved buttons are also available.



Black



Ivory



Pure

Silver
Matte

Black

Light
Bamboo

Amber
Bamboo

Cherry

Walnut

- Battery-operated convenience
- Surface mounts with ease
- Frames available in 7 colors
- Double gang frame available (pure only)

TABLE TOP ACCESSORIES



DecoFlex WireFree™ RTS
Table Top Accessory Black
1811051*



DecoFlex WireFree™ RTS
Table Top Accessory Silver
1810972*



DecoFlex WireFree™ RTS
Table Top Accessory White
1811185*

*DecoFlex Switch sold separately from Table Top Accessory.

Drapery Controls and Accessories

Learn more about controls and accessories at www.somfy.com/controls

RADIO TECHNOLOGY SOMFY® (RTS)



WiFi TO RTS/ZIGBEE INTERFACE



TaHoma Ethernet Adaptor
1870470

TaHoma® RTS/Zigbee
Smartphone & Tablet Interface
1811731

Control window coverings, awnings, screens and rolling shutters using your tablet, smartphone or voice. Create timed events, scenes and more. Integration-ready for third-party control.

16 CHANNEL INTERFACE



Universal RTS Interface 16-Channel
(Converts IR, RS232, RS485 to RTS)
1810872

RTS REPEATER



RTS Repeater
1810791

SOMFY DIGITAL NETWORK™ (SDN)



CONTROL4® TO DIGITAL MOTOR INTERFACE



Receives Zigbee transmissions and converts them to motor control commands.

1870533

SOMFY CONNECT™ LTI



Integrates Somfy RTS and SDN motorized applications with RadioRA® 2, HomeWorks® QS, GRAFIC Eye® QS, and Quantum® control systems.

1870210

SOMFY CONNECT™ UNIVERSAL AUTOMATION INTERFACE (UAI) PLUS



Commission and integrate Somfy-powered SDN solutions over IP.

1870272

SOMFY CONNECT™ BMS INTERFACE



Provides communication between building management systems and SDN motorized shading systems.

1870249

RS485 MODULE FOR IRISMO™ MOTORS (IRISMO DCT TO RS485 UPGRADE)



Converts SDN signals to control commands to operate wired Irismo™ motors.

1811129

RS485 (2-WAY) MODULE FOR GLYDEA® ULTRA MOTORS



Converts SDN signals to control commands to operate wired Glydea® ULTRA motors.

1870275

WIRED TECHNOLOGY



DECORATOR PADDLE SWITCH



Maintained White
1800374
Double Pole,
Double Throw
1800375



Maintained Ivory
1800373
Double Pole,
Double Throw
1800376

For use with Glydea ULTRA wired motors only

DCT (DRY CONTACT TECHNOLOGY)

DRY CONTACT

DRY CONTACT SWITCH



White
1800219



Ivory
1800220

LIMIT SETTING TOOL



For use with Glydea ULTRA & Irismo DCT
9014599

Requires item #9015443
8 ft. Cable with RJ12 Plug

DRAPERY TRACK SPLITTER

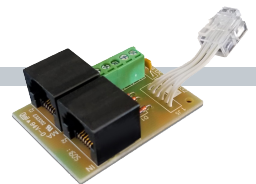











Splitter# 9015442
7 ft. Modular Cable# 9013346
25 ft. Modular Cable# 9013149







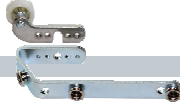

For group & individual control of
DCT drapery motors

Drapery Components







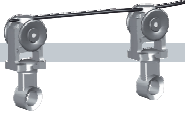
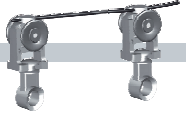
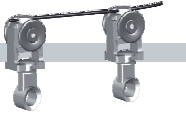

COMMON TRACK COMPONENTS

| | | | |
|--|---|--|---|
| Small Drive Pulley (white & bronze) | Drive Pulley (white & bronze) | Pulley Cover (white & bronze) | Straight Rail Joint |
|  |  |  |  |
| 1782318 | 1782861 | 1780945 | 1782873 |
|  |  | | |
| 1780898 | 1782868 | | |
| Heavy Duty Master Carrier | High Performance 10mm Belt | Track (white & bronze) | |
|  |  |  |  |
| 1781344 | 198' per roll | 96' per carton (6 pcs. x 16') | 228' per carton (12 pcs x 19') |
| Silent Master Carrier | 1782084 | 1780899 per ft. | 9025133 per ft. |
| 1782922 | | | |

RIPPLEFOLD® & ACCORDIA® TRACK COMPONENTS

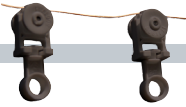
| | | | | |
|--|---|--|---|---|
| Straight Arm Kit | Overlap Arm Kit | One Way Overlap Arm Kit | Ripplefold® Butt Master Arms Kit | |
|  |  |  |  | |
| 1782321 | 1782320 | 1780947 | 1780953 | |
| For use with center opening draperies. | For use with one way and center opening draperies. | For use with tandem alternative straight arm. | For use with center opening draperies only. | |
| One Way Ripplefold® Butt Arm Kit | Straight Arm Kit | Fixing Holder for Ripplefold Runner | 90 Degree Drapery Motor Adaptor Plate | Adjustable Ripplefold Arm Kit |
|  |  |  |  |  |
| 1782319 | 1782662 | 9027657 | 9027179 | 9027045 |
| For use with Ripplefold one way opening and double track tandem alternative. | For use with tandem butted tracks alternative draperies (to be used together). | For use with Ripplefold carriers. Attaches to the master carrier and 1st Ripplefold carrier. | For use with Ripplefold draperies. Provides more aesthetic look. | For use with Ripplefold draperies. Provides more aesthetic look. |

Ripplefold® and Accordia® Type Carriers

| | | | | | |
|--|---|---|---|---|---|
| 80% Fullness (White) | 100% Fullness (White) | 120% Fullness (White) | Ripplefold Silent Runners 80% (White) | Ripplefold Silent Runners 100% (White) | Ripplefold Silent Runners 120% (White) |
|  |  |  |  |  |  |
| Carrier Spacing: 2 3/8" | Carrier Spacing: 2 1/8" | Carrier Spacing: 1 7/8" | Carrier Spacing: 2 3/8" | Carrier Spacing: 2 1/8" | Carrier Spacing: 1 7/8" |
| Qty. per roll: 500 | Qty. per roll: 500 | Qty. per roll: 500 | Qty. per roll: 250 | Qty. per roll: 250 | Qty. per roll: 250 |
| 1780903 | 1780902 | 1780901 | 9027592 | 9027593 | 9027594 |
| 80% Fullness (Bronze) | 100% Fullness (Bronze) | 120% Fullness (Bronze) | Ripple Pendant Only | Ripple Return Snap | Ripple Return Snap |
|  |  |  |  |  |  |
| Carrier Spacing: 2 3/8" | Carrier Spacing: 2 1/8" | Carrier Spacing: 1 7/8" | White | 100 yd. roll: | White |
| Qty. per roll: 500 | Qty. per roll: 500 | Qty. per roll: 500 | 1780948 | 1782301 | Bronze |
| 1782872 | 1782871 | 1782870 | | Per yd. | 1780905 |
| | | | | 1782542 | 1782863 |

Recommended for use with Somfy Ripple Snap Tape (ordered separately), but also adaptable to Kirsch and Graber snap tape. Accordia® type carrier consists of Pinch Pleat carrier and Ripplefold® pendant.

Drapery Components

PINCH PLEAT TRACK COMPONENTS

Straight Arm Kit

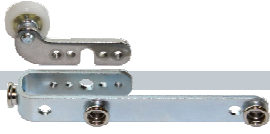

1782321

For use with center opening draperies.

Overlap Arm Kit

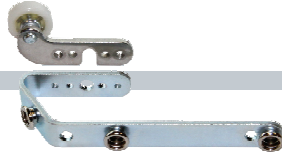

1782320

For use with one way and center opening draperies.

Pinch Pleat Return Hook



White
1780895



Bronze
1782862

Carrier



1781415
Silent Carrier (white only)
1782921



Bronze
1782869

One Way Overlap Arm Kit

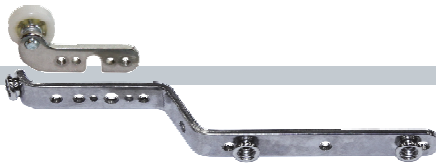

1780947

For use with one way opening draperies with pulley #1780945 & #1782873.

Straight Arm Kit



1782662

For use with tandem butted tracks alternative draperies (to be used with #1780947).

BRACKETS

One Touch Ceiling Bracket



1780907

Adjustable Wall Mount Bracket



Projection 4.5" - 6"
1780909

Double Adjustable Wall Mount Bracket



Projection 8.75" - 10.25"
1780910

Swivel Ceiling Bracket



1780906



Bronze
1782865



Bronze
Projection 4.5" - 6"
1782866



Bronze
Projection 8.75" - 10.25"
1782867



Bronze
1782864

Adjustable Wall/Ceiling Mount Bracket Kit



Projection 4.5" - 6"
1782054

Double Adjustable Wall/Ceiling Mount Bracket Kit

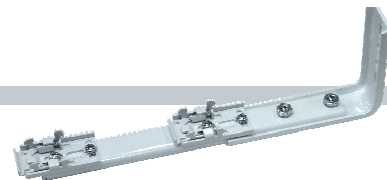

Projection 8.75" - 10.25"
1782053

Product Dimensional Specifications

CARRIER ARM DIMENSIONS

Overlap Arm - #1782320

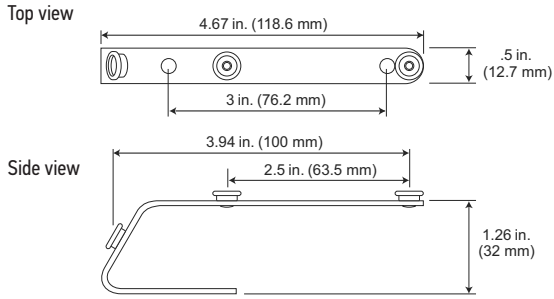

Overlap Arm - #1780947

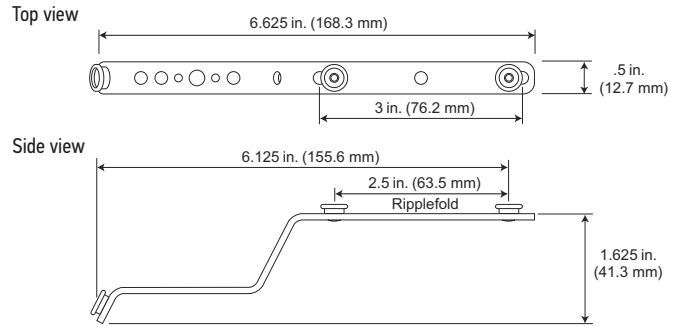

Straight Arm* - #1782321

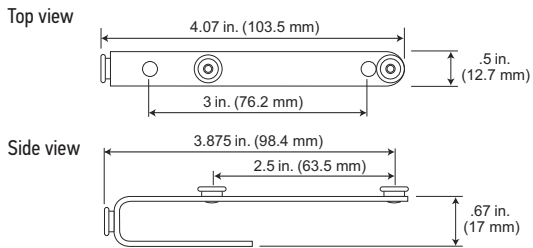

Straight Arm - #1782662

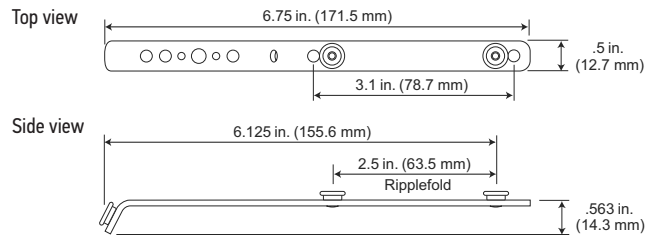

*For use with one-way opening with standard drive pulley.

One Way Butt Arm - #1782319

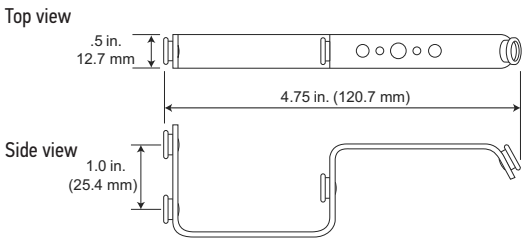

Adjustable Ripplefold Arm kit - #9027045

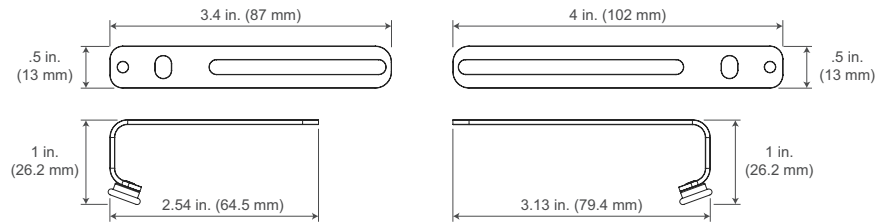

Butt Master Arm Center Opening - #1780953

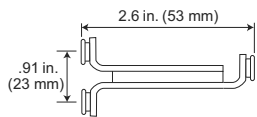

Fixing Holder For Ripplefold Runner - #9027657

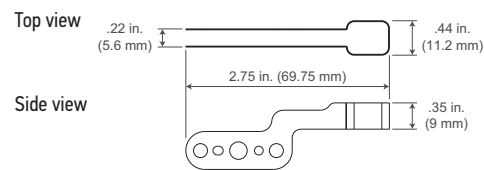

WALL BRACKET DIMENSIONS

Adjustable Wall Mount Bracket - #1780909 & 1782866

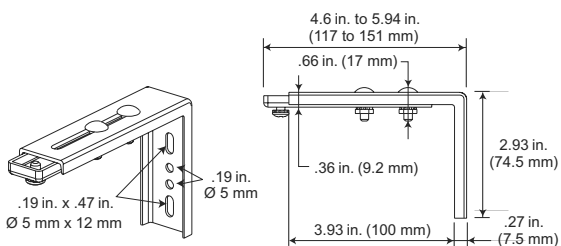

Double Adjustable Wall Mount Bracket - #1780910 & 1782867

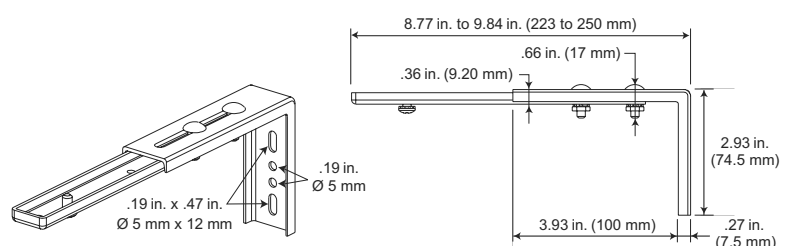

Product Dimensional Specifications

TRACK PROFILE

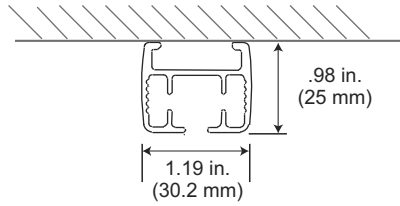

CEILING BRACKET DIMENSIONS

One Touch Ceiling Bracket - #1780907 & 1782865

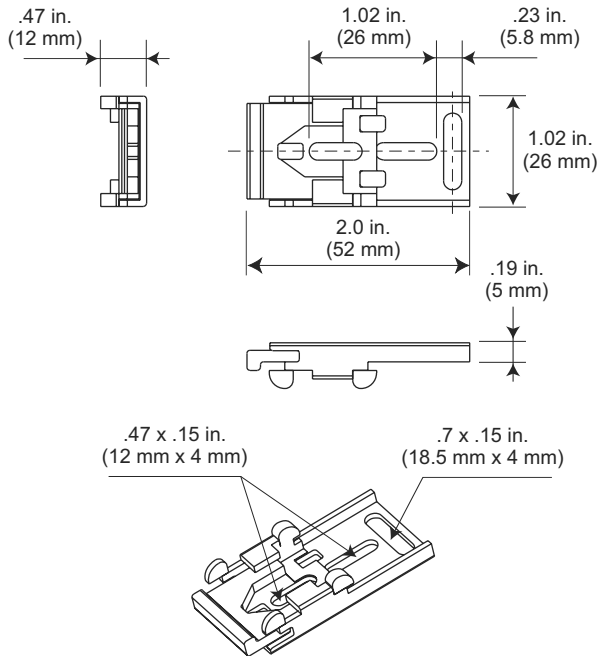

Swivel Ceiling Bracket - #1780906 & 1782864 (recommended for curved tracks)

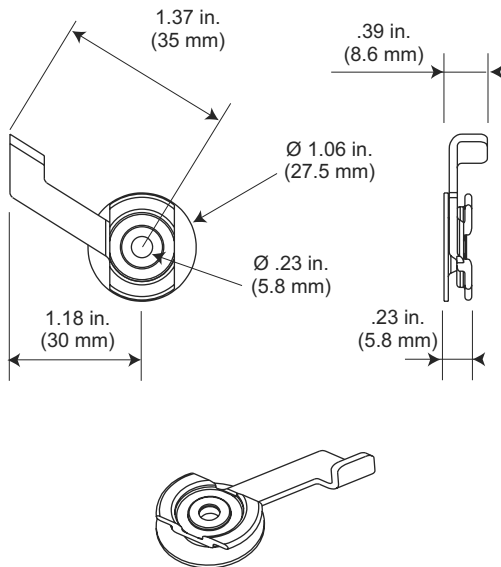

90 Degree Motor Plate - #9027179

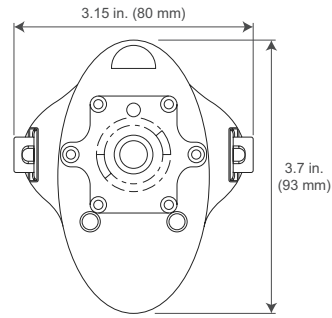

Carriers

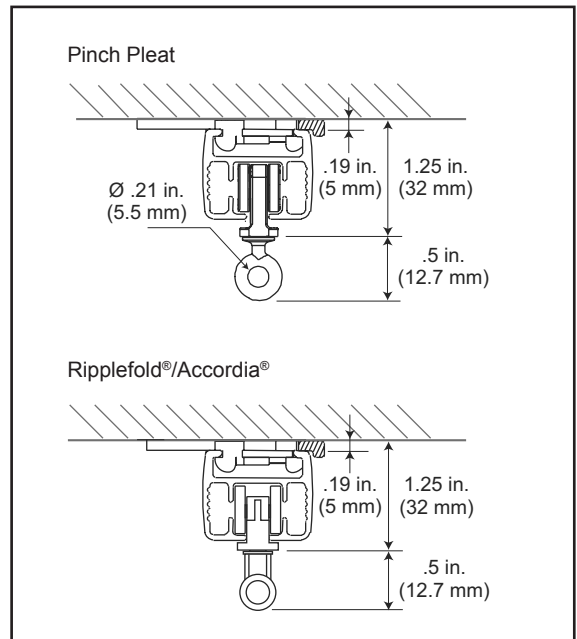

Carriers

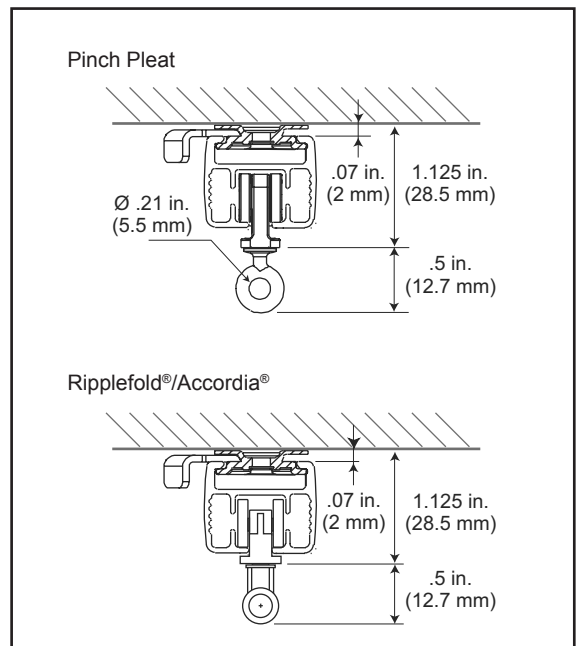

Track Configurations

RIPPLEFOLD® One Way Stacked

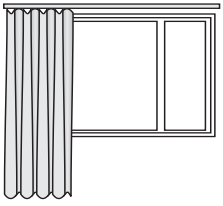

REQUIRED ARMS (1)



REQUIRED ARMS (2)



Bottom-up view of track and drape assembly

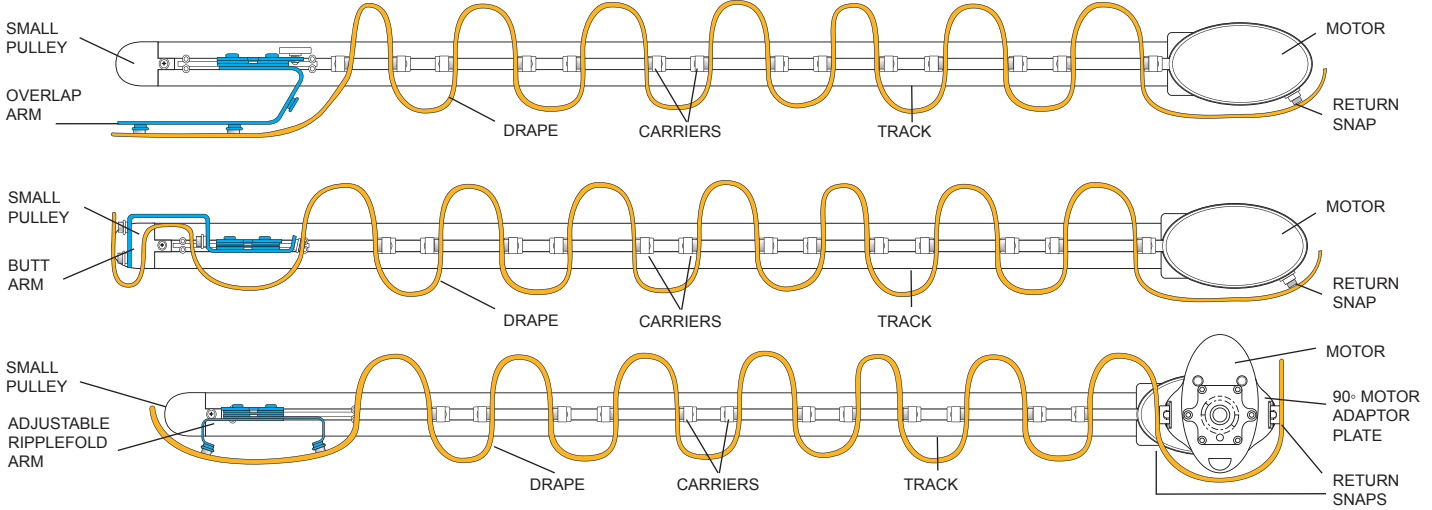

Center Opening

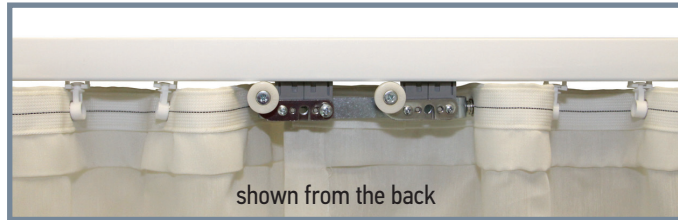
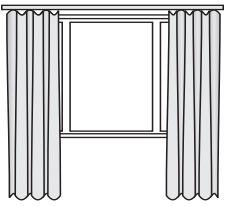

REQUIRED ARMS (1 each)

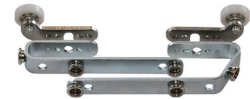

Straight Arm Kit - #1782321
&
Overlap Arm Kit - #1782320

Bottom-up view of track and drape assembly

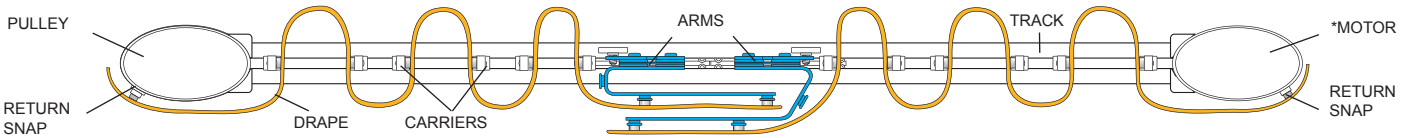

*Motor can be mounted on either side of track.

Center Opening with Butt Master Arms

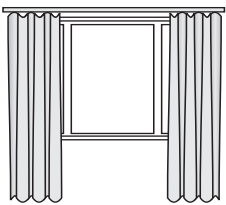

REQUIRED ARMS (2)



Butt Master Arms - #1780953

Bottom-up view of track and drape assembly

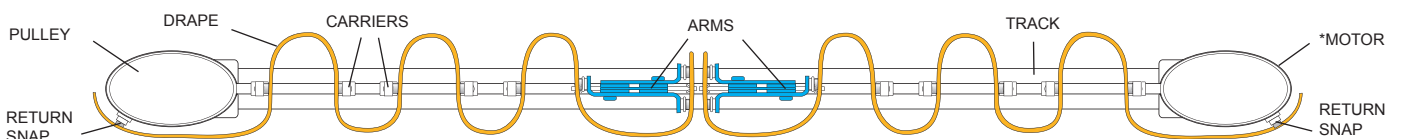

*Motor can be mounted on either side of track.

Track Configurations

PINCH PLEAT One Way Stacked

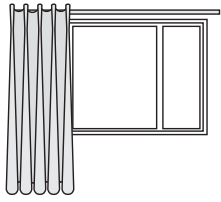

REQUIRED ARMS (1)

One Way Overlap Arm Kit - #1782320



Bottom-up view of track and drape assembly

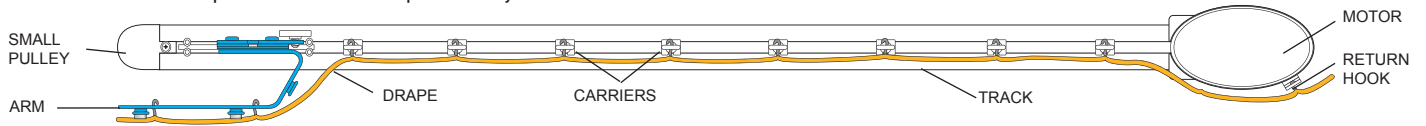

Center Opening

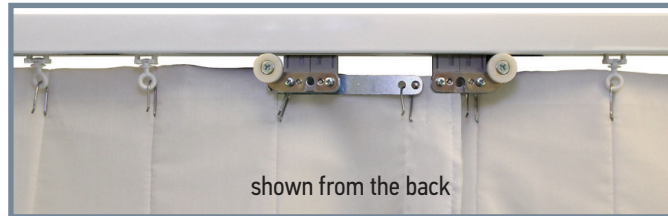
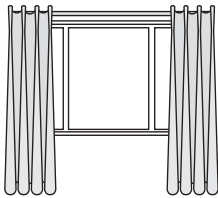

REQUIRED ARMS (1 each)

Straight Arm Kit - #1782321

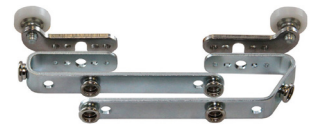

Overlap Arm Kit - #1782320

Bottom-up view of track and drape assembly

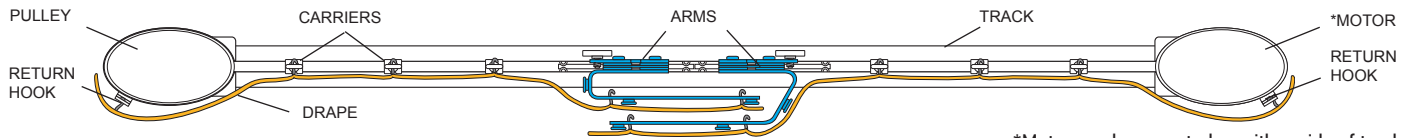

*Motor can be mounted on either side of track.

PINCH PLEAT AND RIPPLEFOLD® Two One Way Butted Tracks (tandem alternative)

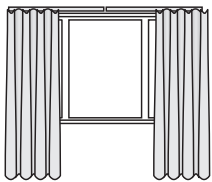

REQUIRED ARMS (2)

One Way Butt Arm Kit - #1782319



REQUIRED ARMS (2)

Straight Arm Kit - #1782662



Overlap Arm Kit - #1780947

Bottom-up view of track and drape assembly

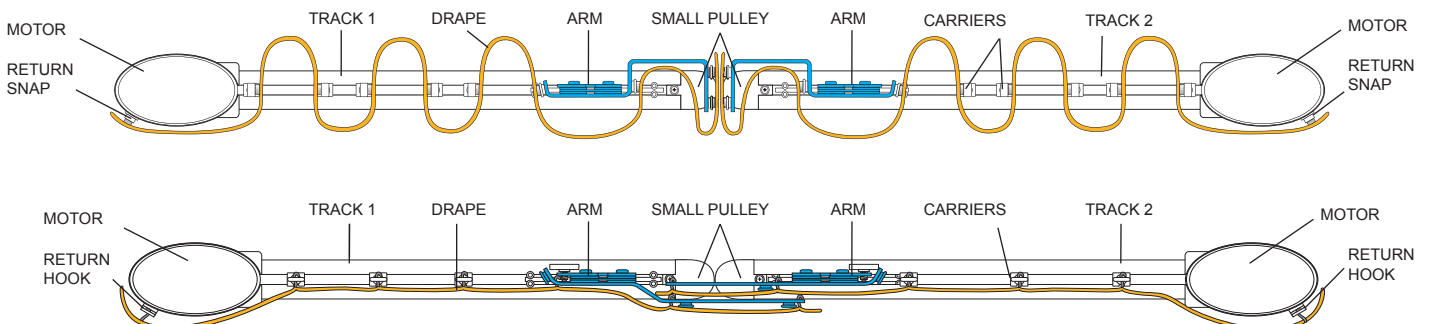

Technical Specifications

SELECTION CHARTS

*STACKING CHART - for reference only

| Track Type | Glydea® 35e & Irismo™ 35 Mini DC | | | Irismo™ 45 WireFree RTS | | | Glydea® 60e | | |
|---|----------------------------------|--------------|--------------|-------------------------|--------------|--------------|--------------|--------------|--------------|
| | UP TO 10 FT. | UP TO 20 FT. | UP TO 32 FT. | UP TO 10 FT. | UP TO 20 FT. | UP TO 33 FT. | UP TO 10 FT. | UP TO 32 FT. | UP TO 36 FT. |
| A One Way | 77 Lbs. | | | 99 Lbs. | | | 132 Lbs. | | |
| B Center Opening | 77 Lbs. | | | 99 Lbs. | | | 132 Lbs. | | |
| C Asymetrical | 77 Lbs. | | | 99 Lbs. | | | 132 Lbs. | | |
| D One Way w/Bend R = 30 cm max (11.8") | 77 Lbs. | 55 Lbs. | 44 Lbs. | 99 Lbs. | 99 Lbs. | 77 Lbs. | 100 Lbs. | 100 Lbs. | 77 Lbs. |
| E Center Opening w/Bend R = 30 cm max (11.8") | 77 Lbs. | 55 Lbs. | 44 Lbs. | 99 Lbs. | 99 Lbs. | 77 Lbs. | 100 Lbs. | 100 Lbs. | 77 Lbs. |
| F One Way w/2 Bends R = 30 cm max (11.8") | 33 Lbs. | 22 Lbs. | - | 77 Lbs. | 66 Lbs. | 44 Lbs. | 77 Lbs. | 55 Lbs. | - |
| G Center Opening w/2 Bends R = 30 cm max (11.8") | 33 Lbs. | 22 Lbs. | - | 77 Lbs. | 66 Lbs. | 44 Lbs. | 77 Lbs. | 55 Lbs. | - |
| H One Way w/Continuous Curve R = 300 cm (118") | 77 Lbs. | 33 Lbs. | - | 77 Lbs. | 44 Lbs. | - | 132 Lbs. | 55 Lbs. | - |
| I Center Opening w/Continuous Curve R = 300 cm (118") | 66 Lbs. | 22 Lbs. | - | 66 Lbs. | 44 Lbs. | - | 113 Lbs. | 38 Lbs. | - |

| TRACK SIZES | RIPPLEFOLD® - inches carrier count - () | | | | | |
|-------------|--|--------------|--------------|--------------------|---------------------|---------------------|
| | ONE WAY 80% | ONE WAY 100% | ONE WAY 120% | CENTER OPENING 80% | CENTER OPENING 100% | CENTER OPENING 120% |
| | Butt Arm | Butt Arm | Butt Arm | Butt Arm | Butt Arm | Butt Arm |
| Up to 4 ft. | 19.5 (20) | 21.5 (24) | 23.5 (28) | 12.25 (20) | 13.25 (24) | 14.25 (28) |
| 5 ft. | 22 (25) | 24.5 (30) | 27 (35) | 13.75 (26) | 14.75 (30) | 16.25 (36) |
| 6 ft. | 24.5 (30) | 27.5 (36) | 30.5 (42) | 14.75 (30) | 16.25 (36) | 17.75 (42) |
| 7 ft. | 27 (35) | 30.5 (42) | 34 (49) | 16.25 (36) | 17.75 (42) | 19.75 (50) |
| 8 ft. | 29.5 (40) | 33.5 (48) | 37.5 (56) | 17.25 (40) | 19.25 (48) | 21.25 (56) |
| 9 ft. | 32 (45) | 36.5 (54) | 41 (63) | 18.75 (46) | 20.75 (54) | 23.25 (64) |
| 10 ft. | 34.5 (50) | 39.5 (60) | 44.5 (70) | 19.75 (50) | 22.25 (60) | 24.75 (70) |
| 11 ft. | 37 (55) | 42.5 (66) | 48 (77) | 21.25 (56) | 23.75 (66) | 26.75 (78) |
| 12 ft. | 39.5 (60) | 45.5 (72) | 51.5 (84) | 22.25 (60) | 25.25 (72) | 28.25 (84) |
| 13 ft. | 42 (65) | 48.5 (78) | 55 (91) | 23.75 (66) | 26.75 (78) | 30.25 (92) |
| 14 ft. | 44.5 (70) | 51.5 (84) | 58.5 (98) | 24.75 (70) | 28.25 (84) | 31.75 (98) |
| 15 ft. | 47 (75) | 54.5 (90) | 62 (105) | 26.25 (76) | 29.75 (90) | 33.75 (106) |
| 16 ft. | 49.5 (80) | 57.5 (96) | 65.5 (112) | 27.25 (80) | 31.25 (96) | 35.25 (112) |
| 17 ft. | 52 (85) | 60.5 (102) | 69 (119) | 28.75 (86) | 32.75 (102) | 37.25 (120) |
| 18 ft. | 54.5 (90) | 63.5 (108) | 72.5 (126) | 29.75 (90) | 34.25 (108) | 38.75 (126) |
| 19 ft. | 57 (95) | 66.5 (114) | 76 (133) | 31.25 (96) | 35.75 (114) | 40.75 (134) |
| 20 ft. | 59.5 (100) | 69.5 (120) | 79.5 (140) | 32.25 (100) | 37.25 (120) | 42.25 (140) |
| 21 ft. | 62 (105) | 72.5 (126) | 83 (147) | 33.75 (106) | 38.75 (126) | 44.25 (148) |
| 22 ft. | 64.5 (110) | 75.5 (132) | 86.5 (154) | 34.75 (110) | 40.25 (132) | 45.75 (154) |
| 23 ft. | 67 (115) | 78.5 (138) | 90 (161) | 36.25 (116) | 41.75 (138) | 47.75 (162) |
| 24 ft. | 69.5 (120) | 81.5 (144) | 93.5 (168) | 37.25 (120) | 43.25 (144) | 49.25 (168) |
| 25 ft. | 72 (125) | 84.5 (150) | 97 (175) | 38.75 (126) | 44.75 (150) | 51.25 (176) |
| 26 ft. | 74.5 (130) | 87.5 (156) | 100.5 (182) | 39.75 (130) | 46.25 (156) | 52.75 (182) |
| 27 ft. | 77 (135) | 90.5 (162) | 104 (189) | 41.25 (136) | 47.75 (162) | 54.75 (190) |
| 28 ft. | 79.5 (140) | 93.5 (168) | 107.5 (196) | 42.25 (140) | 49.25 (168) | 56.25 (196) |
| 29 ft. | 82 (145) | 96.5 (174) | 111 (203) | 43.75 (146) | 50.75 (174) | 58.25 (204) |
| 30 ft. | 84.5 (150) | 99.5 (180) | 114.5 (210) | 44.75 (150) | 52.25 (180) | 59.75 (210) |
| 31 ft. | 87 (155) | 102.5 (186) | 118 (217) | 46.25 (156) | 53.75 (186) | 61.75 (218) |
| 32 ft. | 89.5 (160) | 105.5 (192) | 121.5 (224) | 47.25 (160) | 55.25 (192) | 63.25 (224) |
| 33 ft. | 92 (165) | 108.5 (198) | 125 (231) | 48.75 (166) | 56.75 (198) | 65.25 (232) |
| 34 ft. | 94.5 (170) | 111.5 (204) | 128.5 (238) | 49.75 (170) | 58.25 (204) | 66.75 (238) |
| 35 ft. | 97 (175) | 114.5 (210) | 132 (245) | 51.25 (176) | 59.75 (210) | 68.75 (246) |
| 36 ft. | 99.5 (180) | 117.5 (216) | 135.5 (252) | 52.25 (180) | 61.25 (216) | 70.25 (252) |

DUAL MOTOR TANDEM ALTERNATIVE (2 one way tracks)

| Track Type | | Irismo™ 45 WireFree RTS | | | Glydea® 60e | | | Glydea® 35e & Irismo™ 35 Mini DC | | |
|--------------------------------------|--------------|-------------------------|--------------|--------------|--------------|--------------|--------------|----------------------------------|--------------|--------------|
| | | UP TO 10 FT. | UP TO 20 FT. | UP TO 33 FT. | UP TO 10 FT. | UP TO 32 FT. | UP TO 36 FT. | UP TO 10 FT. | UP TO 20 FT. | UP TO 32 FT. |
| J Center opening w/2 Straight | (1) Straight | 99 Lbs. | | | 132 Lbs. | | | 77 Lbs. | | |
| | (1) Straight | 99 Lbs. | | | 132 Lbs. | | | 77 Lbs. | | |
| K Center opening w/1 Bend | (1) 90° Bend | 99 Lbs. | 99 Lbs. | 33 Lbs. | 100 Lbs. | 77 Lbs. | 77 Lbs. | 55 Lbs. | 44 Lbs. | |
| | (1) Straight | 99 Lbs. | | | 132 Lbs. | | | 77 Lbs. | | |
| L Center opening w/2 Bends | (1) 90° Bend | 99 Lbs. | 99 Lbs. | 77 Lbs. | 100 Lbs. | 77 Lbs. | 77 Lbs. | 55 Lbs. | 44 Lbs. | |
| | (1) 90° Bend | 99 Lbs. | 99 Lbs. | 77 Lbs. | 100 Lbs. | 77 Lbs. | 77 Lbs. | 55 Lbs. | 44 Lbs. | |
| M Center opening w/2 Curves | (1) Curve | 77 Lbs. | 44 Lbs. | - | 132 Lbs. | 55 Lbs. | - | 77 Lbs. | 33 Lbs. | - |
| | (1) Curve | 77 Lbs. | 44 Lbs. | - | 132 Lbs. | 55 Lbs. | - | 77 Lbs. | 33 Lbs. | - |

* Measurements do not consider drapery fabric and are calculated from end of pulley to front of master arm (shown here).

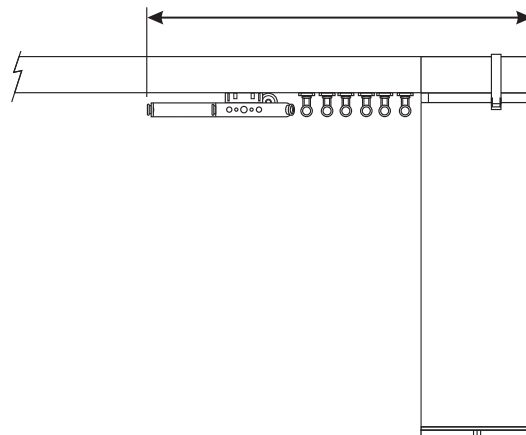

Technical Specifications

*STACKING CHART CONT'D - for reference only

| TRACK SIZES | RIPPLEFOLD® - inches carrier count - () | | | | | | | | | PINCH PLEAT - inches carrier count - () | | |
|-------------|---|-----------------|-----------------|-----------------------|-----------------|------------------------|-----------------|------------------------|-----------------|---|----------------|-----------------|
| | ONE WAY 80% | ONE WAY 100% | ONE WAY 120% | CENTER OPENING 80% | | CENTER OPENING 100% | | CENTER OPENING 120% | | ONE WAY | CENTER OPENING | |
| | Overlap Arm | Overlap Arm | Overlap Arm | Overlap Arm | Straight Arm | Overlap Arm | Straight Arm | Overlap Arm | Straight Arm | Overlap Arm | Overlap Arm | Straight Arm |
| Up to 4 ft. | 19.25 (20) | 21.25 (24) | 23.25 (28) | 14 (10) | 13.75 (10) | 15 (12) | 14.75 (12) | 16.25 (14) | 16 (14) | 15.25 (12) | 11.75 (6) | 11.5 (6) |
| 5 ft. | 21.75 (25) | 24.25 (30) | 26.75 (35) | 15.5 (13) | 15.25 (13) | 16.5 (15) | 16.25 (15) | 18.25 (18) | 18 (18) | 16.75 (15) | 12.75 (8) | 12.5 (8) |
| 6 ft. | 24.25 (30) | 27.25 (36) | 30.25 (42) | 16.5 (15) | 16.25 (15) | 18 (18) | 17.75 (18) | 19.75 (21) | 19.5 (21) | 18.25 (18) | 13.25 (9) | 13 (9) |
| 7 ft. | 26.75 (35) | 30.25 (42) | 33.75 (49) | 18 (18) | 17.75 (18) | 19.5 (21) | 19.25 (21) | 21.75 (25) | 21.5 (25) | 19.75 (21) | 14.25 (11) | 14 (11) |
| 8 ft. | 29.25 (40) | 33.25 (48) | 37.25 (56) | 19 (20) | 18.75 (20) | 21 (24) | 20.75 (24) | 23.25 (28) | 23 (28) | 21.25 (24) | 14.75 (12) | 14.5 (12) |
| 9 ft. | 31.75 (45) | 36.25 (54) | 40.75 (63) | 20.5 (23) | 20.25 (23) | 22.5 (26) | 22.25 (26) | 25.25 (32) | 25 (32) | 22.75 (27) | 15.75 (14) | 15.5 (14) |
| 10 ft. | 34.25 (50) | 39.25 (60) | 44.25 (70) | 21.5 (25) | 21.25 (25) | 24 (30) | 23.75 (30) | 26.75 (35) | 26.5 (35) | 24.25 (30) | 16.25 (15) | 16 (15) |
| 11 ft. | 36.75 (55) | 42.25 (66) | 47.75 (77) | 23 (28) | 22.75 (28) | 25.5 (33) | 25.25 (33) | 28.75 (39) | 28.5 (39) | 25.75 (33) | 17.25 (17) | 17 (17) |
| 12 ft. | 39.25 (60) | 45.25 (72) | 51.25 (84) | 24 (30) | 23.75 (30) | 27 (36) | 26.75 (36) | 30.25 (42) | 30 (42) | 27.25 (36) | 17.75 (18) | 17.5 (18) |
| 13 ft. | 41.75 (65) | 48.25 (78) | 54.75 (91) | 25.5 (33) | 25.25 (33) | 28.5 (39) | 28.25 (39) | 32.25 (46) | 32 (46) | 28.75 (39) | 18.75 (20) | 18.5 (20) |
| 14 ft. | 44.25 (70) | 51.25 (84) | 58.25 (98) | 26.5 (35) | 26.25 (35) | 30 (42) | 29.75 (42) | 33.75 (49) | 33.5 (49) | 30.25 (42) | 19.25 (21) | 19 (21) |
| 15 ft. | 46.75 (75) | 54.25 (90) | 61.75 (105) | 28 (38) | 27.75 (38) | 31.5 (45) | 31.25 (45) | 35.75 (53) | 35.5 (53) | 31.75 (45) | 20.25 (23) | 20 (23) |
| 16 ft. | 49.25 (80) | 57.25 (96) | 65.25 (112) | 29 (40) | 28.75 (40) | 33 (48) | 32.75 (48) | 37.25 (56) | 37 (56) | 33.25 (48) | 20.75 (24) | 20.5 (24) |
| 17 ft. | 51.75 (85) | 60.25 (102) | 68.75 (119) | 30.5 (43) | 30.25 (43) | 34.5 (51) | 34.25 (51) | 39.25 (60) | 39 (60) | 34.75 (51) | 21.75 (26) | 21.5 (26) |
| 18 ft. | 54.25 (90) | 63.25 (108) | 72.25 (126) | 31.5 (45) | 31.25 (45) | 36 (54) | 35.75 (54) | 40.75 (63) | 40.5 (63) | 36.25 (54) | 22.25 (27) | 22 (27) |
| 19 ft. | 56.75 (95) | 66.25 (114) | 75.75 (133) | 33 (48) | 32.75 (48) | 37.5 (57) | 37.25 (57) | 42.75 (67) | 42.5 (67) | 37.75 (57) | 23.25 (29) | 23 (29) |
| 20 ft. | 59.25 (100) | 69.25 (120) | 79.24 (140) | 34 (50) | 33.75 (50) | 39 (60) | 38.75 (60) | 44.25 (70) | 44 (70) | 39.25 (60) | 23.75 (30) | 23.5 (30) |
| 21 ft. | 61.75 (105) | 72.25 (126) | 82.75 (147) | 35.5 (53) | 35.25 (53) | 40.5 (63) | 40.25 (63) | 46.25 (74) | 46 (74) | 40.75 (63) | 24.75 (32) | 24.5 (32) |
| 22 ft. | 64.25 (110) | 75.25 (132) | 86.25 (154) | 36.5 (55) | 36.25 (55) | 42 (66) | 41.75 (66) | 47.75 (77) | 47.5 (77) | 42.25 (66) | 25.25 (33) | 25 (33) |
| 23 ft. | 66.75 (115) | 78.25 (138) | 89.75 (161) | 38 (58) | 37.75 (58) | 43.5 (69) | 43.25 (69) | 49.75 (81) | 49.5 (81) | 43.75 (69) | 26.25 (35) | 26 (35) |
| 24 ft. | 69.25 (120) | 81.25 (144) | 93.25 (168) | 39 (60) | 38.75 (60) | 45 (72) | 44.75 (72) | 51.25 (84) | 52 (84) | 45.25 (72) | 26.75 (36) | 26.5 (36) |
| 25 ft. | 71.75 (125) | 84.25 (150) | 96.75 (175) | 40.5 (63) | 40.25 (63) | 46.5 (75) | 46.25 (75) | 53.25 (88) | 53 (88) | 46.75 (75) | 27.75 (38) | 27.5 (38) |
| 26 ft. | 74.25 (130) | 87.25 (156) | 100.25 (182) | 41.5 (65) | 41.25 (65) | 48 (78) | 47.75 (78) | 54.75 (91) | 54.5 (91) | 48.25 (78) | 28.25 (39) | 28 (39) |
| 27 ft. | 76.75 (135) | 90.25 (162) | 103.75 (189) | 43 (68) | 42.75 (68) | 49.5 (81) | 49.25 (81) | 56.75 (95) | 56.5 (95) | 49.75 (81) | 29.25 (41) | 29 (41) |
| 28 ft. | 79.25 (140) | 93.25 (168) | 107.25 (196) | 44 (70) | 43.75 (70) | 51 (84) | 50.75 (84) | 58.25 (98) | 58 (98) | 51.25 (84) | 29.75 (42) | 29.5 (42) |
| 29 ft. | 81.75 (145) | 96.25 (174) | 110.75 (203) | 45.5 (73) | 45.25 (73) | 52.5 (87) | 52.25 (87) | 60.25 (102) | 60 (102) | 52.75 (87) | 30.75 (44) | 30.5 (44) |
| 30 ft. | 84.25 (150) | 99.25 (180) | 114.25 (210) | 46.5 (75) | 46.25 (75) | 54 (90) | 53.75 (90) | 61.75 (105) | 61.5 (105) | 54.25 (90) | 31.25 (45) | 31 (45) |
| 31 ft. | 86.75 (155) | 102.3 (186) | 117.75 (217) | 48 (78) | 47.75 (78) | 55.5 (93) | 55.25 (93) | 63.75 (108) | 63.5 (108) | 55.75 (93) | 32.25 (47) | 32 (47) |
| 32 ft. | 89.25 (160) | 105.3 (192) | 121.25 (224) | 49 (80) | 48.75 (80) | 57 (96) | 56.75 (96) | 65.25 (112) | 65 (112) | 57.25 (96) | 32.75 (48) | 32.5 (48) |
| 33 ft. | 91.75 (165) | 108.3 (198) | 124.75 (231) | 50.5 (83) | 50.25 (83) | 58.5 (99) | 58.25 (99) | 67.25 (116) | 67 (116) | 58.75 (99) | 33.75 (50) | 33.5 (50) |
| 34 ft. | 94.25 (170) | 111.3 (204) | 128.25 (238) | 51.5 (85) | 51.25 (85) | 60 (102) | 59.75 (102) | 68.75 (118) | 68.5 (118) | 60.25 (102) | 34.25 (51) | 34 (51) |
| 35 ft. | 96.75 (175) | 114.3 (210) | 131.75 (245) | 53 (86) | 52.75 (86) | 61.5 (105) | 61.25 (105) | 70.75 (123) | 70.5 (123) | 61.75 (105) | 35.25 (53) | 35 (53) |
| 36 ft. | 99.25 (180) | 117.3 (216) | 135.25 (252) | 54 (90) | 53.75 (90) | 63 (108) | 62.75 (108) | 72.25 (126) | 72 (126) | 63.25 (108) | 35.75 (54) | 35.5 (54) |

Drapery Fabricated Track Options*

*Fabricated tracks are available upon request. For more information, please contact Somfy sales.

AVAILABLE CARRIER ARMS

Carrier arms are included with fabricated motorized drapery tracks per the opening type.

ONE WAY OPENING

Overlap Arm - For use with one way opening Pinch Pleat, one way Ripplefold® and Accordia® draperies. Qty 1 per drapery track.



One Way Overlap Arm Kit
1782320

CENTER OPENING

Overlap Arm - For use with center opening Pinch Pleat, Ripplefold® and Accordia® draperies. Qty 1 Overlap Arm per drapery track. Qty 1 Straight Arm per drapery track.



Overlap Arm Kit
1782320
Straight Arm Kit
1782321

CENTER OPENING BUTT MASTER

Butt Master Arm - For use with Ripplefold® and Accordia® center opening draperies only. Qty 2 per drapery track required.



or (optional)
Butt Master Arms
1780953

ONE WAY OPENING OR TWO MOTOR TANDEM

One Way Butt Arm - For use with Ripplefold® one way draperies and 2 motor tandem alternative. Qty 1 per drapery track required.

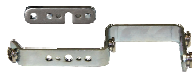

One Way Butt Arm Kit
1782320

TWO MOTOR TANDEM ALTERNATIVE

Overlap Arm/ Straight Arm - For use with Pinch Pleat and 2 motor tandem alternative. Qty 1 per drapery track required.

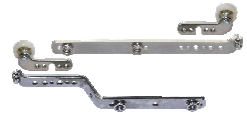

Straight Arm Kit
1782662
Overlap Arm Kit
1780947

AVAILABLE CARRIERS

Standard Carriers are included with fabricated motorized drapery tracks.

PINCH PLEAT DRAPERIES

****Pinch Pleat Carriers:** Somfy includes a quantity of 3 carriers per foot. Additional carriers can be ordered if necessary.



Carrier
1781415
Bronze
1782869



****See page 25 for carrier counts.**

RIPPLEFOLD SILENT RUNNERS

Ripplefold Silent Runners 80%
Qty per roll: 250



White
9027592

Ripplefold Silent Runners 100%
Qty per roll: 250



White
9027593

Pinch Pleat Return Hook:

Qty 2 for One Way Draw (included)
Qty 4 for Center Opening (included)



Return Hook
1780895
Bronze
1782862



Ripplefold Silent Runners 120%
Qty per roll: 250

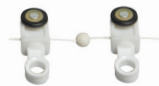

White
9027594

Ripple Pendant Only



1780948

RIPPLEFOLD®/ACCORDIA® DRAPERIES

*****Somfy Standard Ripplefold/Accordia Type Carriers:** The quantity of carriers needed depends on the desired fullness, reference the chart below to determine the needed quantity and standard spacing. Each carrier comes complete with pendant. See page 24-25 for carrier counts.

| Item # (white) | Item # (bronze) | Fullness | ***Carrier Spacing |
|----------------|-----------------|----------|-------------------------------|
| 1780903 | 1782872 | 80% | 2 3/8" / 5 per ft. (included) |
| 1780902 | 1782871 | 100% | 2 1/8" / 6 per ft. (included) |
| 1780901 | 1782870 | 120% | 1 7/8" / 7 per ft. (included) |

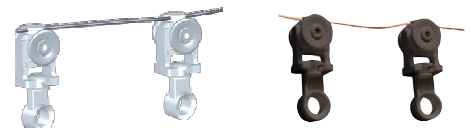

Carrier and Pendant

*****Note: Quantity per ft. is included with each fabricated track. Fullness must be specified when order is placed.** Recommended for use with Somfy Ripple Snap Tape (ordered separately), but also adaptable to Kirsch and Graber snap tape.

Ripple Snap Tape:



(100 yd. roll) 1782301
(per yd.) 1782542

Return Snap:

Qty 2 for One Way Draw (included)
Qty 4 for Center Opening (included)



Return Snap
1780905
Bronze
1782863



Custom Track Options

Tandem Alternative

Tandem alternative RTS motorized systems utilize two drapery motors and are used for draperies that exceed the maximum single motor capacity. Tandem systems are also available with dry contact control technologies and require additional accessories.

See pages 22 & 23 for track configurations and specification details



Top Mount

Drapery motors can be installed above the drapery track depending on your project needs. This option provides the ability to conceal the motor in a drop ceiling or under a valence and requires an additional kit.

Top Mount Kit
#1780908

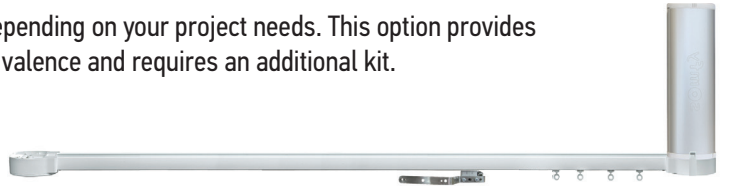

Glystro® Conversion Kit

The Glystro® conversion kit is designed to allow adaptation to Somfy's current drapery motors to previous Glystro® drapery tracks and associated hardware.



#1782106

Bends

Tracks with bends are ideal for bay and corner windows. Track bends are available at a fixed radius of 11.8 in. For more information on how to measure for a bend, please see page 28.

Bent Drapery Track Measurement Form required for all orders.

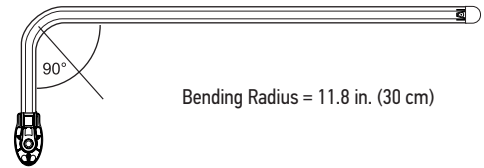

Curves

Custom curves are ideal for bow windows and other special applications. For additional information on how to measure for a curve, and how to make a template, please see [Directions for Creating a Template for Drapery Curves](#) page 29.

Templates are required for accuracy for all orders.

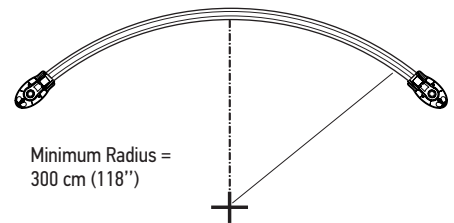

BRACKET MOUNTING RECOMMENDATIONS (TOP VIEW OF TRACK)

Somfy recommends 1 bracket by each pulley and 1 bracket every 24 in. Also, 1 bracket should be placed on each side of a splice if used.

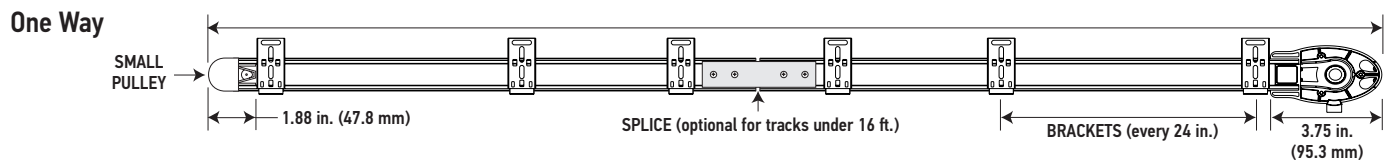
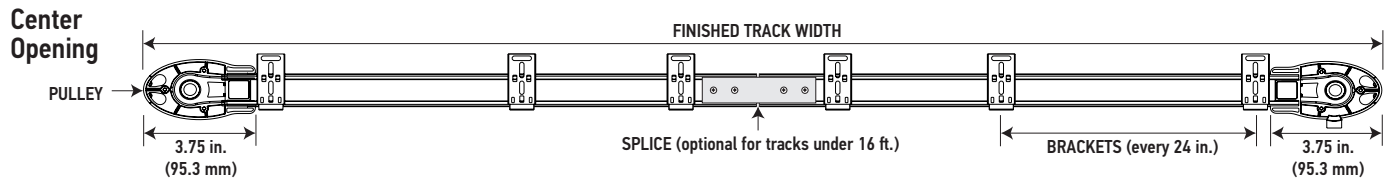

DRAPERY ORDER FORM & RESOURCES

Date of Order: _____ Account # _____ P.O. # _____ Sidemark: _____

Special Shipping Directions: _____

| SOLD TO: | |
|----------------|-------------------------------|
| Business Name: | _____ |
| Address: | _____ |
| City: | _____ State: _____ Zip: _____ |
| Phone: | _____ Fax #: _____ |
| Email: | _____ |
| Ordered By: | _____ |
| Signature: | _____ |

| SHIP TO: | |
|----------------|-------------------------------|
| Business Name: | _____ |
| Address: | _____ |
| City: | _____ State: _____ Zip: _____ |
| Contact Name: | _____ |
| Phone: | _____ Fax #: _____ |
| Email: | _____ |

ORDER DETAIL: Please see next page for glossary and definition of terms.

| Item # | Room | QTY. | 1 | 2 | 3 | 4 | 5 | 6 | 7 | 8 | 9 | 10 | | 11 | 12 |
|--------|-------------|------|----------------|-------------|--------|------------|-------------|-------------|---------------|-----------------------|--------------|---------|------|---------|-------------|
| | | | Motor Part No. | Width (in.) | Tandem | Motor Side | *Track Type | Track Color | Stack (L/R/S) | **If Bent: # of bends | Carrier Type | Part # | QTY. | Bracket | Butt Master |
| ex. | Living Room | 1 | 1003152 | 144 | Y/N | L | F | WHT/BRZ | S | 2 | RF80 | 1780907 | 7 | NO | X |
| 1 | | | | | | | | | | | | | | | |
| 2 | | | | | | | | | | | | | | | |
| 3 | | | | | | | | | | | | | | | |
| 4 | | | | | | | | | | | | | | | |
| 5 | | | | | | | | | | | | | | | |
| 6 | | | | | | | | | | | | | | | |

* For curved tracks, Somfy requires a template be provided. Please see [Directions for Creating a Template for Drapery Curves](#) for template information.

** For bent tracks, Somfy does not require a template. Please include the [Bent Drapery Tracks Measurement Form](#) for exact measurements per angle and return.

NOTE: Somfy includes a center splice every 16' of track. Please indicate in the "SPECIAL INSTRUCTIONS" section if your requirements differ from Somfy's standard.

| CONTROLS: |
|---|
| In the space provided below, please list the part number(s) for the control(s) you desire. |
| Given the nature of custom motorization products, control options and compatibility varies dramatically. If you would like further assistance with control options, simply note it in the field below and one of our customer service specialists will contact you upon the submission of your order. |
| |

| SPECIAL INSTRUCTIONS |
|----------------------|
| |

Please send to: e-mail: ordering_us@somfy.com Fax: 609-495-8117



| 1 | Motor | Part Number |
|---|--|-------------|
| | Glydea® ULTRA 35 Motor RTS with 10' Plug | 1003152 |
| | Glydea® ULTRA 35 Motor DCT with 10' Plug | 1003151 |
| | Glydea® ULTRA 60 Motor RTS with 10' Plug | 1003159 |
| | Glydea® ULTRA 60 Motor DCT with 10' Plug | 1003158 |
| | Glydea® ULTRA 35 Wired Motor with 10' Plug | 1003153 |
| | Glydea® ULTRA 60 Wired Motor with 10' Plug | 1003160 |
| | Irismo™ 35 (Mini DC) RTS | 1003004 |
| | Irismo™ 35 (Mini DC) DCT | 1003003 |
| | Irismo™ 45 WireFree RTS | 1002353 |

2 Width (Inches)
 Motorized drapery tracks are custom built according to the specified width. Please note that the finished track width is measured pulley end to pulley end. For bent and curved tracks please provide the total of all wall measurements. When fabricating your drapery please add 1.5" to your return.

3 Tandem Y=Yes N=No
 Tandem motorized systems utilize two drapery motors. Items needed for tandem systems should be noted in the Special Instructions Section of the order form.
Tandem alternative = 2 one way tracks
Requires Glydea ULTRA DCT or IRISMO 35 DCT motors.

4 Motor Side
L=Left Side R=Right Side
 Choose the motor side best suited for your installation.

5 Track Type
A-I See below 0=Other
 NOTE: Somfy requires a template for all curved tracks. Add an "S" after Track Type for Silent Master Carrier option (ie., "A-S"). Please see **Directions for Creating a Template for Drapery Curves** for necessary information.

| | | |
|-------------------------|---|---|
| A One way | D One way w/Bend R = 30 cm max (11.8") | G Center Opening w/2 Bends R = 30 cm max (11.8") |
| B Center Opening | E Center Opening w/Bend R = 30 cm max (11.8") | H One Way w/ Continuous Curve R = 300 cm max (118") |
| C Asymetrical | F One way w/ 2Bends R = 30 cm max (11.8") | I Center Opening w/Continuous Curve R = 300 cm max (118") |

6 Track Color - White or Bronze

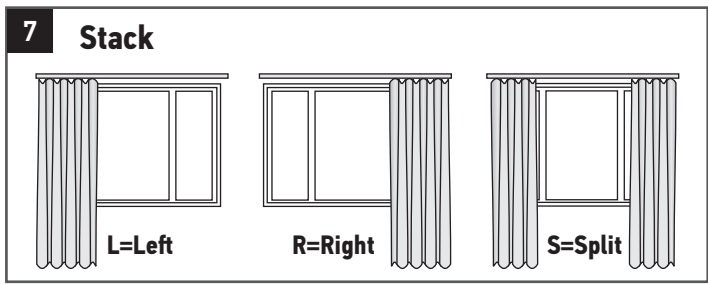

8 If Bent: # of Bends
1=1 Bend, 2=2 Bends, 3=3 Bends, etc
 NOTE: Somfy requires exact angle measurements for all bent tracks. Please submit completed and signed **Bent Drapery Track Measurement Form** with all bent track orders.

9 Carrier/Runner Type
1=1 Bend, 2=2 Bends, 3=3 Bends, etc
 SPP=Silent Pinch Pleat (QTY of 3 per foot included)
 PP=Pinch Pleat (QTY of 3 per foot included)
 RF80 = RippleFold® 80% fullness (QTY of 5 per foot spaced every 2 3/8" included)
 RF100 = RippleFold® 100% fullness (QTY of 6 per foot spaced every 2 1/8" included)
 RF120 = RippleFold® 120% fullness (QTY of 7 per foot spaced every 1 7/8" included)

10 Brackets
 NOTE: Brackets are not included and must be ordered separately.

| Part Numbers | White | Bronze |
|---|-----------|----------------|
| One Touch Ceiling Bracket (not recommended for curved tracks)..... | # 1780907 |# 1782865 |
| 4.5"-6" Wall Mount Bracket..... | # 1782054 |# 9025621 |
| 8.75"-10.25" Double Wall Mount Bracket..... | # 1782053 |# 9025622 |
| Swivel Ceiling Bracket (strongly recommended for curved tracks).... | # 1780906 |# 1782864 |

Somfy recommends one (1) bracket by each pulley and one (1) bracket every 24". Additionally, one (1) bracket should be placed on each side of a splice if used.

11 Butt Master
Y=Yes N=No
 Only available for RippleFold® center opening systems. Quantity 2 required; please note item numbers in **Special Instructions Section** of the order form item #1780953.

12 Splice
X=Special splice instructions
 Somfy includes a center splice every 16ft of track. Please indicate in the Special Instructions Section if your requirements differ from Somfy's standard.

BENT DRAPERY TRACK MEASUREMENT FORM

1. Choose the design that best fits your room setup.
2. Measure the wall and degrees of all angles as in examples shown below.
 - Make sure to provide the return measurement "R" (distance from wall to front of drapery track as shown in red). The bent track measurement form represents wall measurements, therefore the "R" dimension MUST BE specified for accurate track fabrication. If "R" dimension IS NOT specified, drapery track will be fabricated according to dimensions (A, B, C, D, etc.) provided.
 - Return dimensions will not be considered, and measurements will be calculated from center of each bend.
 - When fabricating drapery, please add an additional 1.5 inches of drapery fabric to the anticipated return size.
3. Provide all measurements by filling out order form and submitting to Somfy.

NOTE: The following dimensions are shown from top view of the track and show various wall designs.

STYLE 1 MEASUREMENT

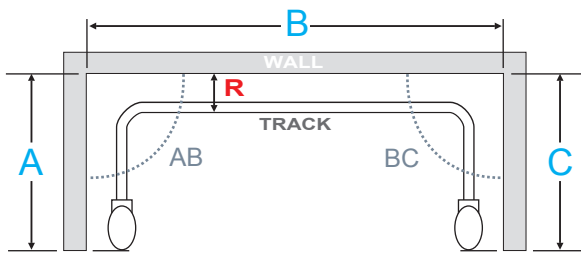

STYLE 2 MEASUREMENT

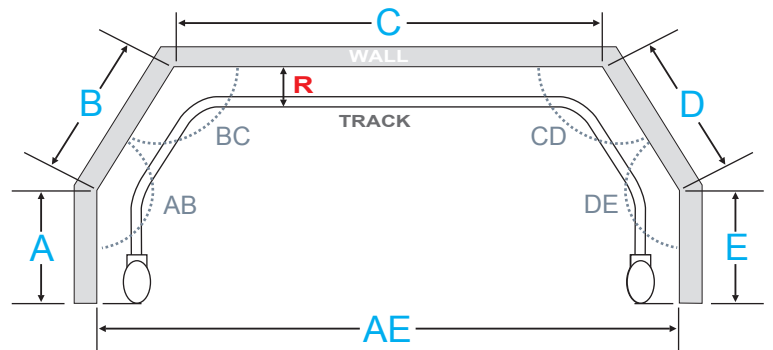

STYLE 3 MEASUREMENT

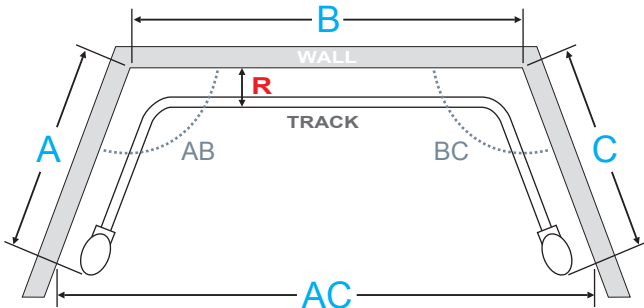

STYLE 4 MEASUREMENT

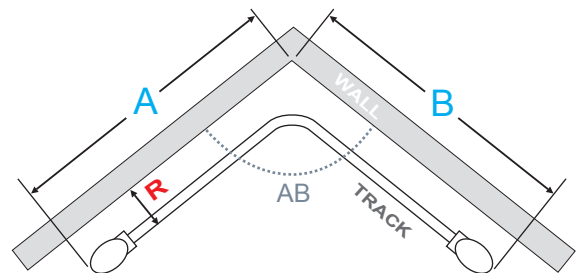

STYLE 5 MEASUREMENT *

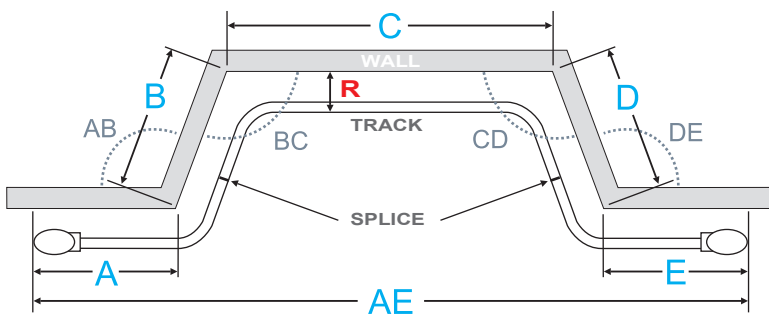

* Splices are required for this style.

| TRACK 1 | |
|---------------|-----------------|
| "R" Dimension | _____ |
| Style | _____ Degree of |
| A | _____ Bend |
| B | _____ AB |
| C | _____ BC |
| D | _____ CD |
| E | _____ DE |
| AC | _____ |
| AE | _____ |

| TRACK 2 | |
|---------------|-----------------|
| "R" Dimension | _____ |
| Style | _____ Degree of |
| A | _____ Bend |
| B | _____ AB |
| C | _____ BC |
| D | _____ CD |
| E | _____ DE |
| AC | _____ |
| AE | _____ |

DIRECTIONS FOR CREATING A TEMPLATE FOR DRAPERY CURVES

What you need: • Large piece of construction paper • Tape Measure • Marker • Tape

- 1** Start with a large piece of construction paper that exceeds the depth and length of the curve.
- 2** Place the paper on the floor or ceiling depending on the orientation of the curve.
- 3** Secure the paper with tape.
- 4** Clearly define the stacking side, motor placement, pocket depth and center line of track with the marker.
- 5** Mark the radius of the curve.

Please call Somfy for specialty curving applications. Depending on your particular application, your project may require special attention.

- 6** Please provide as much detail as possible and all templates must include the following:
 - Indicate "room side"
 - Note how the template was created
 - Purchase order number
 - Template created on the floor facing up (See Figure 1) *preferred method*
 - Template created on the ceiling facing down (See Figure 2)
 - Template must indicate "Carriers DOWN" or "Carriers UP"
 - Customer name
 - Company name and account number
- 7** Note the distance from the wall or the window to the center of the track.
NOTE: be sure to clear all possible obstructions such as handles, sills etc.
- 8** Identify the following measurement points:
 - Placement of motor
 - Exact stopping point of track on template
 - Total measurement of curve (See Figure 4-"C")

FIGURE 1: TEMPLATE ON THE FLOOR FACING UP

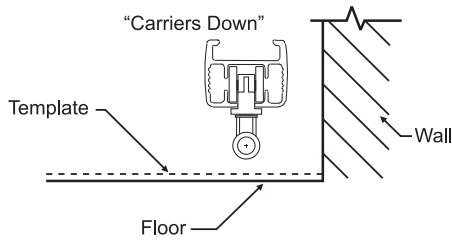

FIGURE 2: TEMPLATE ON CEILING FACING DOWN

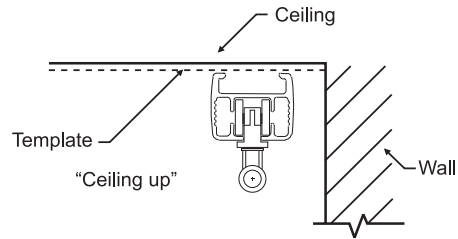

FIGURE 3: CRITICAL DIMENSIONS OF A CURVED TRACK

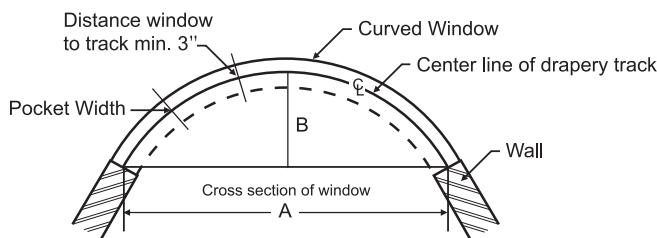
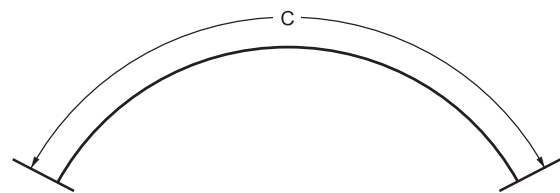

FIGURE 4: TOTAL MEASUREMENT OF CURVE



Template Submission Instructions

- Attach a copy of the purchase order to the template.
- Roll up template and place in a mailing tube.

DO NOT FOLD TEMPLATE

NOTE: When mailing, be sure to:

- Get a tracking number
- Include your return address
- Include your purchase order number on the label

Mail to:

Somfy Systems, Inc.
121 Herrod Blvd.
Dayton, NJ 08810
Attn: Drapery Department

Acceptable materials for making templates:

- Kraft Paper • Butcher Paper • Construction Paper

Somfy will not accept template made from the following materials:

- Newspaper • Plastic • Wax Paper • Fabric • Tissue Paper
- Roofing Paper • Existing Arch Shades • Wrapping Paper

NOTE: If the material used to make a template stretches, tears easily, will not lay flat or will mark the fabric - IT WILL NOT BE USED.

DECOFLEX KEYPAD BUTTON ENGRAVING FORM

<https://www.somfypro.com/decoflex-custom-button>
<https://www.somfypro.ca/decoflex-custom-button>

Customer Name: _____ Customer #: _____

| | | |
|-----------------|---|-------------------------------|
| SHIPPING | Shipping Information | Project Information |
| | Ship to: Default Shipping Address <input type="checkbox"/> Drop Ship <input type="checkbox"/> | Project Name: _____ |
| | Name: _____ | Installer Name/Company: _____ |
| | Address: _____ | P/O #: _____ Order #: _____ |
| | City: _____ State: _____ Zip: _____ | Area: _____ |
| | Phone: _____ | Room: _____ |

| | | |
|--------------|---|--|
| STYLE | Button Color | Switch Type |
| | WHITE <input type="checkbox"/> #9018259 | RTS <input type="checkbox"/> Somfy Digital Network (SDN) RS485 <input type="checkbox"/> Dry Contact <input type="checkbox"/> |
| | IVORY <input type="checkbox"/> #9018260 | <i>Including the SDN Group Keypad Available in White only</i> |
| | BLACK <input type="checkbox"/> #9018261 | <i>Available in White only</i> |

| | | | | | | | | | | | | | | | | | | | | | | | | | | | | | | | | | | | | | | | | | | | | | | | | | | | | | | | | | | | | | | | | | | | | | | | | | | | | | | | | | | | |
|--------------------------|--|---|--|--|--|--|--|--|--|--|--|---|--|--|--|--|--|--|--|--|--|---|--|--|--|--|--|--|--|--|--|---|--|--|--|--|--|--|--|--|--|---|--|--|--|--|--|--|--|--|--|----|--|--|--|--|--|--|--|--|--|---|--|--|--|--|--|--|--|--|--|---|--|--|--|--|--|--|--|--|--|----------------------------|---|
| ENGRAVING OPTIONS | <p>Buttons (A-F) 9 Characters Maximum (including spaces) QTY.</p> <table border="1"> <tr><td>A</td><td></td><td></td><td></td><td></td><td></td><td></td><td></td><td></td><td></td></tr> <tr><td>B</td><td></td><td></td><td></td><td></td><td></td><td></td><td></td><td></td><td></td></tr> <tr><td>C</td><td></td><td></td><td></td><td></td><td></td><td></td><td></td><td></td><td></td></tr> <tr><td>D</td><td></td><td></td><td></td><td></td><td></td><td></td><td></td><td></td><td></td></tr> <tr><td>E</td><td></td><td></td><td></td><td></td><td></td><td></td><td></td><td></td><td></td></tr> <tr><td>F*</td><td></td><td></td><td></td><td></td><td></td><td></td><td></td><td></td><td></td></tr> <tr><td>G</td><td></td><td></td><td></td><td></td><td></td><td></td><td></td><td></td><td></td></tr> <tr><td>H</td><td></td><td></td><td></td><td></td><td></td><td></td><td></td><td></td><td></td></tr> </table> | A | | | | | | | | | | B | | | | | | | | | | C | | | | | | | | | | D | | | | | | | | | | E | | | | | | | | | | F* | | | | | | | | | | G | | | | | | | | | | H | | | | | | | | | | <p>DecoFlex RTS</p> | <p>DecoFlex SDN (Standalone or Group)</p> <p>(A-H) Programmable buttons for individual or groups of SDN RS485 motors</p> <p>Note: pre-labelled with STOP, UP and DOWN arrows</p> |
| | A | | | | | | | | | | | | | | | | | | | | | | | | | | | | | | | | | | | | | | | | | | | | | | | | | | | | | | | | | | | | | | | | | | | | | | | | | | | | | | | | | | |
| | B | | | | | | | | | | | | | | | | | | | | | | | | | | | | | | | | | | | | | | | | | | | | | | | | | | | | | | | | | | | | | | | | | | | | | | | | | | | | | | | | | | |
| | C | | | | | | | | | | | | | | | | | | | | | | | | | | | | | | | | | | | | | | | | | | | | | | | | | | | | | | | | | | | | | | | | | | | | | | | | | | | | | | | | | | |
| | D | | | | | | | | | | | | | | | | | | | | | | | | | | | | | | | | | | | | | | | | | | | | | | | | | | | | | | | | | | | | | | | | | | | | | | | | | | | | | | | | | | |
| | E | | | | | | | | | | | | | | | | | | | | | | | | | | | | | | | | | | | | | | | | | | | | | | | | | | | | | | | | | | | | | | | | | | | | | | | | | | | | | | | | | | |
| | F* | | | | | | | | | | | | | | | | | | | | | | | | | | | | | | | | | | | | | | | | | | | | | | | | | | | | | | | | | | | | | | | | | | | | | | | | | | | | | | | | | | |
| | G | | | | | | | | | | | | | | | | | | | | | | | | | | | | | | | | | | | | | | | | | | | | | | | | | | | | | | | | | | | | | | | | | | | | | | | | | | | | | | | | | | |
| | H | | | | | | | | | | | | | | | | | | | | | | | | | | | | | | | | | | | | | | | | | | | | | | | | | | | | | | | | | | | | | | | | | | | | | | | | | | | | | | | | | | |
| | NOTE: | <p>* (F): Command Button by default is labeled STOP on the DecoFlex Range of keypads. G and H buttons by default are labeled as follows: (G = down ▼ icon) WHITE - #9018263 IVORY - #9018264 BLACK - #9018265 (H = up ▲ icon): WHITE - #9018267 IVORY - #9018268 BLACK - #9018269</p> <p>If you prefer they can be substituted with an associated command NAME (UP, DOWN, LOWER, etc.) up to 5 characters.</p> | | | | | | | | | | | | | | | | | | | | | | | | | | | | | | | | | | | | | | | | | | | | | | | | | | | | | | | | | | | | | | | | | | | | | | | | | | | | | | | | | |

Engraving Options - Default option will be used if nothing is selected.
Character Types: (choose one)

ALL LETTERS CAPITALIZED (Default) First Letters Capitalized As written in above section

Payment terms of your account will apply.
All engraved switches are custom made and are non-cancellable.
Please send form to: Fax # 609-495-8117 or e-mail to: Ordering_us@somfy.com

| | | | |
|---|---|---|---|
| <p>SOMFY SYSTEMS INC 121 Herrod Blvd. Dayton, NJ 08810 Phone: (800) 22-SOMFY NJ: (609) 395-1300 Fax: (609) 495-8118 somfypro.com</p> | <p>Florida 1200 SW 35th Ave. Boynton Beach, FL 33426 Phone: (877) 227-6639 Fax: (561) 995-7502</p> | <p>California 15301 Barranca Parkway Irvine, CA 92618-2201 Phone: (877) 727-6639 Fax: (949) 727-3775</p> | <p>SOMFY ULC SOMFY Canada Division 6411 Edwards Blvd Mississauga, ON L5T 2P7 CN: (905) 564-6446 Fax: (905) 238-1491 somfypro.ca</p> |
|---|---|---|---|



SMOOVE® WALL SWITCH RANGE

Smoove Plate Engraving Order Form

Available for Pure frames only

Customer Name: _____ Customer #: _____

| | | |
|-----------------|---|-------------------------------|
| SHIPPING | Shipping Information | Project Information |
| | Ship to: Default Shipping Address <input type="checkbox"/> Drop Ship <input type="checkbox"/> | Project Name: _____ |
| | Name: _____ | Installer Name/Company: _____ |
| | Address: _____ | P/O #: _____ Order #: _____ |
| | City: _____ State: _____ Zip: _____ | Area: _____ |
| Phone: _____ | Room: _____ | |

| | | | |
|--------------|---|---|---|
| STYLE | Switch Plate Type | Assembled Switch | Stacking (Double Frame only) |
| | SINGLE-GANG <input type="checkbox"/> #9027376 | DOUBLE-GANG <input type="checkbox"/> #9027377 | 1-CHANNEL <input type="checkbox"/> #1871191 (Switch + Plate included) |
| | | 4-CHANNEL <input type="checkbox"/> #1871192 (Switch + Plate included) | VERTICAL <input type="checkbox"/> HORIZONTAL <input type="checkbox"/> |

SEE EXAMPLES ON NEXT PAGE

| ENGRAVING OPTIONS | Wall Plate | Custom Text | Maximum | Text** | Characters | Qty. |
|--------------------------|------------|-------------|------------|--------------------|------------|------|
| | Positions | Positions | Characters | | | |
| | 1 | A | 5 | TEXT ONLY | | |
| | | B | | | | |
| | | C | | | | |
| | | D | | | | |
| | 2 | | 16 | Text or Your Logo* | | |
| | 3 | E | 5 | TEXT ONLY | | |
| | | F | | | | |
| | | G | | | | |
| | | H | | | | |
| | 4 | | 16 | Text or Your Logo* | | |
| | 5 | | 16 | Text or Your Logo* | | |
| | 6 | I | 5 | TEXT ONLY | | |
| | | J | | | | |
| | | K | | | | |
| | | L | | | | |
| | 7 | | 16 | Text or Your Logo* | | |
| | 8 | M | 5 | TEXT ONLY | | |
| | | N | | | | |
| | | O | | | | |
| | | P | | | | |

*Company logo may be used on this side of the wall plate.

**Logo specs: Maximum dimension: 1.97 in (5cm) wide x .39 in. (1cm) high
File format (type): .dxf files only

Engraving Options - Default option will be used if nothing is selected.

Character Types: (choose one)

- ALL LETTERS CAPITALIZED (Default) First Letters Capitalized As written in above section

SMOOVE® WALL SWITCH RANGE

Smooove Plate Engraving Order Form

ENGRAVING OPTIONS (cont.)

Single Frame

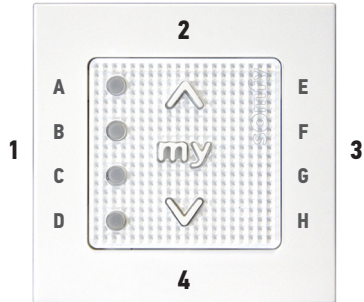

Dual Frame - Horizontal

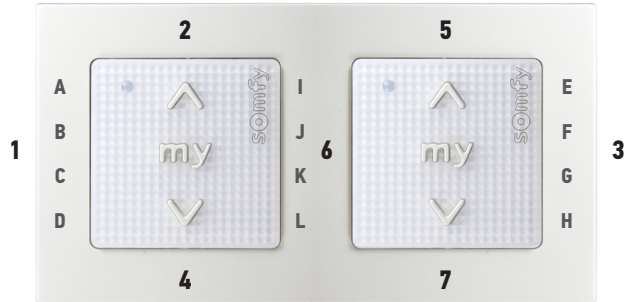

Dual Frame - Vertical*

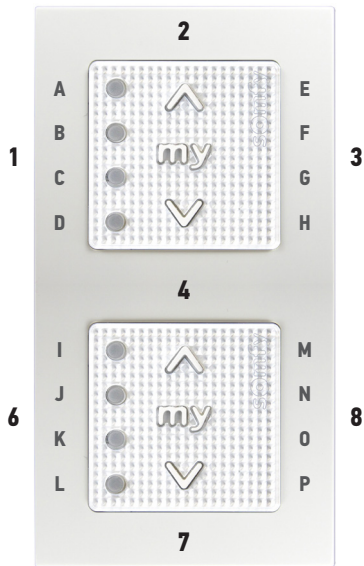

*NOTE: #5 intentionally omitted

Example:

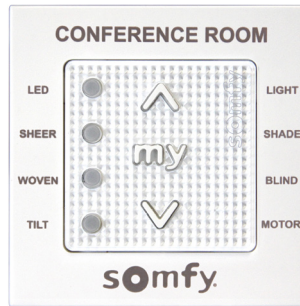

Payment terms of your account will apply.

All engraved wall plates are custom made and are non-cancellable.

Please send form to: Fax # 609-495-8117 or e-mail to: Ordering_us@somfy.com

SOMFY SYSTEMS INC
121 Herrod Blvd.
Dayton, NJ 08810
Phone: (800) 22-SOMFY
NJ: (609) 395-1300
Fax: (609) 495-8118
somfypro.com

Florida
1200 SW 35th Ave.
Boynton Beach, FL 33426
Phone: (877) 227-6639
Fax: (561) 995-7502

California
15301 Barranca Parkway
Irvine, CA 92618-2201
Phone: (877) 727-6639
Fax: (949) 727-3775

SOMFY ULC
SOMFY Canada Division
6411 Edwards Blvd
Mississauga, ON L5T 2P7
CN: (905) 564-6446
Fax: (905) 238-1491

About Somfy®

Somfy has been improving everyday life for more than 270 million people by designing and manufacturing intelligent motorization solutions for interior window coverings and exterior solar protections. Somfy innovates to automate and connect shades, blinds, draperies, awnings, rolling shutters, exterior screens & pergolas for commercial and residential buildings in 58 countries across the globe. With 170+ million motors produced over the last half century, Somfy is committed to creating reliable and sustainable solutions that promote the best way of living and well-being for all.

SOMFY SYSTEMS INC SOMFY NORTH AMERICAN HEADQUARTERS

121 Herrod Blvd.
Dayton, NJ 08810
P: (800) 22-SOMFY (76639)
NJ: (609) 395-1300
F: (609) 395-1776

FLORIDA

1200 SW 35th Ave.
Boynton Beach, FL 33426
P: (800) 22-SOMFY (76639)
F: (561) 995-7502

CALIFORNIA

15301 Barranca Parkway
Irvine, CA 92618-2201
P: (800) 22-SOMFY (76639)
F: (949) 727-3775

SOMFY ULC SOMFY Canada Division

6411 Edwards Blvd
Mississauga, ON L5T 2P7
P: (800) 66-SOMFY (76639)
CN: (905) 564-6446
F: (905) 238-1491

www.somfypro.com

A BRAND OF **SOMFY** GROUP

© Somfy Systems, Inc. 8/2022
Images: © SAS/Childeric

